

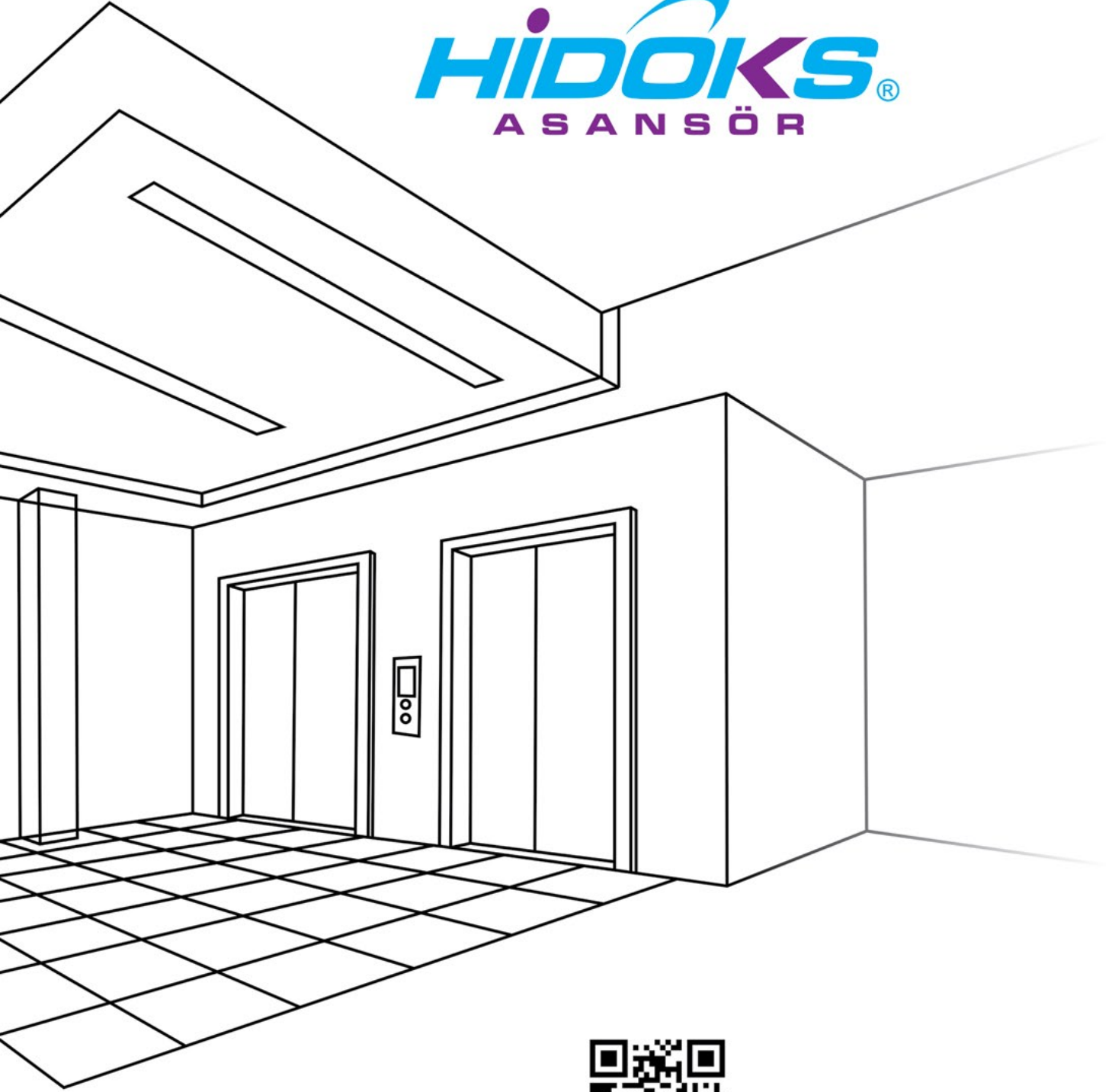

**HIDOKS**<sup>®</sup>  
ASANSÖR



[www.hidoks.com.tr](http://www.hidoks.com.tr)  
[bilgi@hidoks.com.tr](mailto:bilgi@hidoks.com.tr)

# İçindekiler

## Index

## Содержание

## الفهرس

<b>02</b> <b>Sertifikalar</b> Our Certificates Сертификаты شهاداتا	<b>03</b> <b>Firma Profili</b> Company Profile Профиль Компании عن الشركة	<b>04 - 05</b> <b>İhracat</b> Export Экспорт تصدير
<b>06 - 47</b> <b>Kabinler</b> Cabines Кабины الكبائن	<b>48 - 54</b> <b>Kapılar</b> Doors Двери أبواب	<b>55 - 59</b> <b>Sistemler</b> Suspention Types Шахта أنظمة التعليق
<b>60 - 61</b> <b>Platformlar</b> Platforms Платформ بلاتفورم	<b>62 - 64</b> <b>Butonlar</b> Operating Panels Кнопки لوحات الطلب	<b>65 - 67</b> <b>Makine Motorlar</b> Traction Machines Лебедки المحركات
<b>68 - 70</b> <b>Panolar</b> Panels Система Управления الكونترولات	<b>71 - 81</b> <b>Aksesuarlar</b> Accessories Аксессуары ملحقات	<b>82 - 87</b> <b>Yedek Parçalar</b> Spare Parts Запчасти قطع الغيار





Hidoks Asansör gerekli her türlü eğitim ve donanıma sahip geniş kadrosuyla üretim, montaj, periyodik bakım, onarım ve servis faaliyetlerini sürdürmektedir. Kusursuz müşteri memnuniyeti ilkesi ile faaliyetini sürdüren firmamız; imalat, montaj, bakım, proje konularında kalite, performans, uygun fiyat ve dünya standartları ölçülerine göre çalışmalarını sürdürmekte ve hedeflediği müşteri potansiyeline ulaşmaktadır. Satış ve teslimat sonrası periyodik bakım hizmetleri yanında verdiği garanti güvencesiyle müşteri memnuniyetine de güç katmaya devam etmektedir. Hidoks Asansör kalitesi, araştırmacılığı, gelişen dünyayı ve teknolojiyi esas alarak yarınlara emin adımlarla ilerlemektedir.

Hidoks Asansör continues its activities in production, installation, regular maintenance, repair and service with its extensive staff equipped with all necessary training and equipment. Continuing its activities with the principle of complete customer satisfaction, our company works in the field of production, installation, maintenance and project according to quality, performance, reasonable price and world standards and reaches the customer potential that it targets. It continues to contribute to customer satisfaction with the warranty it provides in addition to regular post-sale and post-delivery maintenance services. Hidoks Asansör is taking firm steps into the future with its quality and based on research, the developing world and technology.

Компания "Hidoks Asansör" с помощью имеющегося большого штата сотрудников, имеющих необходимую подготовку и оснащение, успешно продолжает свою деятельность в области производства, монтажа, периодического технического обслуживания, ремонта и сервиса. Наша компания, которая в своей деятельности руководствуется принципом совершенного удовлетворения потребностей клиентов, занимается производством, сборкой, техническим обслуживанием, проектами в области обеспечения качества, производительности, приемлемых цен, продолжая осуществлять свою деятельность в соответствии с мировыми стандартами и достигая своего целевого потенциала клиентов. Помимо предоставления услуг по периодическому техническому обслуживанию после реализации и доставки, компания продолжает способствовать повышению удовлетворенности клиентов с помощью гарантий, которые она предоставляет. Компания "Hidoks Asansör" решительными шагами устремляется в будущее, ориентируясь на качество, исследования, развивающийся мир и технологии.

تستمر شركة هيدوكس للمصاعد Hidoks في القيام بنشاطاتها في مجال الإنتاج والتجميع والصيانة الدورية وخدمة التصليح وذلك من خلال طاقمها الكبير المجهز بكامل التدريبات والمعدات الضرورية بمختلف أنواعها. شركتنا , التي تؤدي نشاطاتها وفق قاعدة الرضا التام للعملاء من دون أدنى تقصير ; وتواصل القيام بأعمالها وفقاً لمعايير الجودة والتنفيذ والسعر المناسب والمعايير العالمية في التصنيع والتجميع والصيانة ومواضيع المشروع وبذلك تصل إلى توقعات فئة العملاء المستهدفة. تستمر الشركة بإضافة اطمئنان لرضا العملاء من خلال الضمان الذي تقدمه المتضمن خدمات الصيانة الدورية بعد بيع وتسليم المنتج . شركة هيدوكس للمصاعد Hidoks تخطو خطوات ثابتة نحو المستقبل مستندة إلى الجودة والبحث والعالم المتقدم والتكنولوجيا.







  
**HIDOKS**®  
ASANSÖR

  
**HiLIFT**  
DISABLED ELEVATORS & COMPLETE SOLUTIONS

**HIDOOR**   
AUTOMATIC DOOR



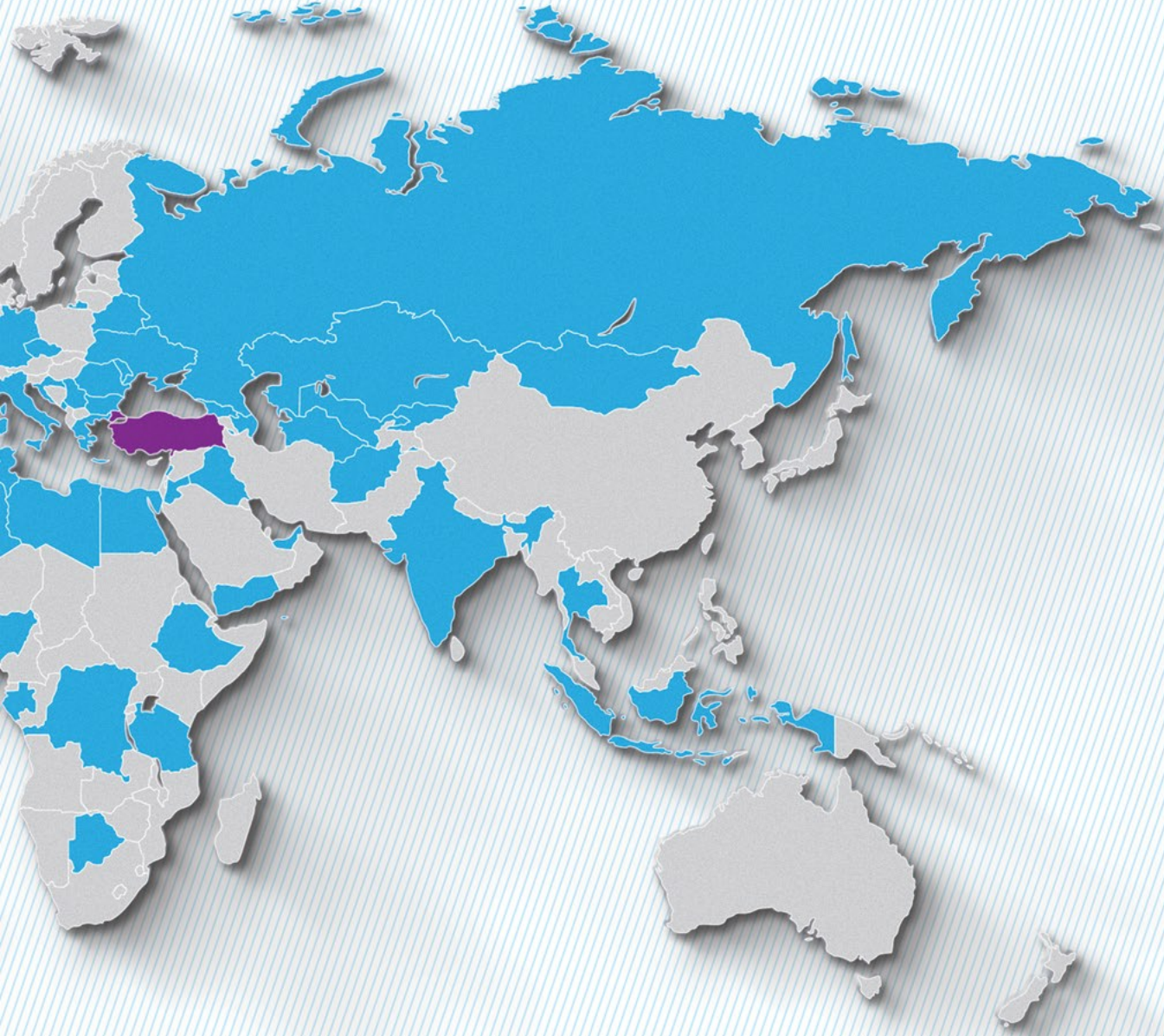

**Kalitemizi yüksekere,  
Konforumuzu sizlere...**

*To raise our quality to the highest*

COMPLETE  
**ELEVATOR**  
SYSTEMS





güncel  
ve teknolojiler  
tecrübemizle...



الكبائن  
cabins кабины  
kabinler

up to date technology  
and experience...

## MARITA

Kabinler aydınlatma ve havalandırma sistemleri ile donatılmıştır.

Cabins equipped by lighting and ventilation systems.

Освещение кабин и оснащен вентиляционными системами.

مجھرة قیاسیا بأنظمة الانارة و التهوية و فرامل الأمان



TAVAN | CEILING | ПОТОЛОК | سقف



Doğal Taş  
Natural Stone  
Природный Камень  
حجر طبيعي

DUVAR | WALL | СТЕНА | جدار



Doğal Taş  
Natural Stone  
Природный Камень  
حجر طبيعي

TABAN | FLOOR | БАЗА | الأرضية



Doğal Granit  
Natural Granite  
Натуральный Гранит  
الجرانيت الطبيعي



güncel teknolojiler  
ve tecrübemizle...



## PERLA

Kabinler aydınlatma ve havalandırma sistemleri ile donatılmıştır.

Cabins equipped by lighting and ventilation systems.

Освещение кабин и оснащён вентиляционными системами.

مجھرة قیاسیا بأنظمة الانارة و التهوية و فرامل الأمان



TSEK ISO EAC CE

TAVAN | CEILING | ПОТОЛОК | سقف



Lazer Kesim  
Laser Drawing  
Лазерная Резка  
محفور بالليزر

DUVAR | WALL | СТЕНА | جدار



Laminant  
Laminat  
Ламинат  
الخشاب

TABAN | FLOOR | БАЗА | الأرضية



Doğal Granit  
Natural Granite  
Натуральный Гранит  
الجرانيت الطبيعي



up to date technology  
and experience...

## BELLA

Kabinler aydınlatma ve havalandırma sistemleri ile donatılmıştır.

Cabins equipped by lighting and ventilation systems.

Освещение кабин и оснащен вентиляционными системами.

مجھرة قیاسیا بأنظمة الإنارة و التهوية و فرامل الأمان



TAVAN | CEILING | ПОТОЛОК | سقف



Lazer Kesim  
Laser Drawing  
Лазерная Резка  
القطع بالليزر

DUVAR | WALL | СТЕНА | جدار



Paslanmaz Sac  
Stainless Steel Sheet  
Нержавеющая Сталь  
ستانلس ستیل

TABAN | FLOOR | БАЗА | الأرضية



Doğal Granit  
Natural Granite  
Натуральный Гранит  
الجرانيت الطبيعي



güncel teknolojiler  
ve tecrübemizle...



## CORRADO

Kabinler aydınlatma ve havalandırma sistemleri ile donatılmıştır.

Cabins equipped by lighting and ventilation systems.

Освещение кабин и оснащён вентиляционными системами.

مجھرة قیاسیا بأنظمة الانارة و التهوية و فرامل الأمان



TSEK ISO EAC CE

TAVAN | CEILING | ПОТОЛОК | سقف



Lazer Kesim  
Laser Drawing  
Лазерная Резка  
القطع بالليزر

DUVAR | WALL | СТЕНА | جدار



Paslanmaz Sac  
Stainless Steel Sheet  
Нержавеющая Сталь  
صفائح الفولاذ المقاوم للصدأ

TABAN | FLOOR | БАЗА | الأرضية



Doğal Granit  
Natural Granite  
Натуральный Гранит  
الجرانيت الطبيعي



up to date technology  
and experience...

## BLANKO

Kabinler aydınlatma ve havalandırma sistemleri ile donatılmıştır.

Cabins equipped by lighting and ventilation systems.

Освещение кабин и оснащен  
вентиляционными системами.

مجھرة قیاسیا بأنظمة الإنارة و التهوية و فرامل الأمان



TAVAN | CEILING | ПОТОЛОК | سقف



Lazer Kesim  
Laser Drawing  
Лазерная Резка  
القطع بالليزر

DUVAR | WALL | СТЕНА | جدار



Paslanmaz Sac  
Stainless Steel Sheet  
Нержавеющая Сталь  
صفائح الفولاذ المقاوم للصدأ

TABAN | FLOOR | БАЗА | الأرضية



Doğal Granit  
Natural Granite  
Натуральный Гранит  
الجرانيت الطبيعي



güncel teknolojiler  
ve tecrübemizle...

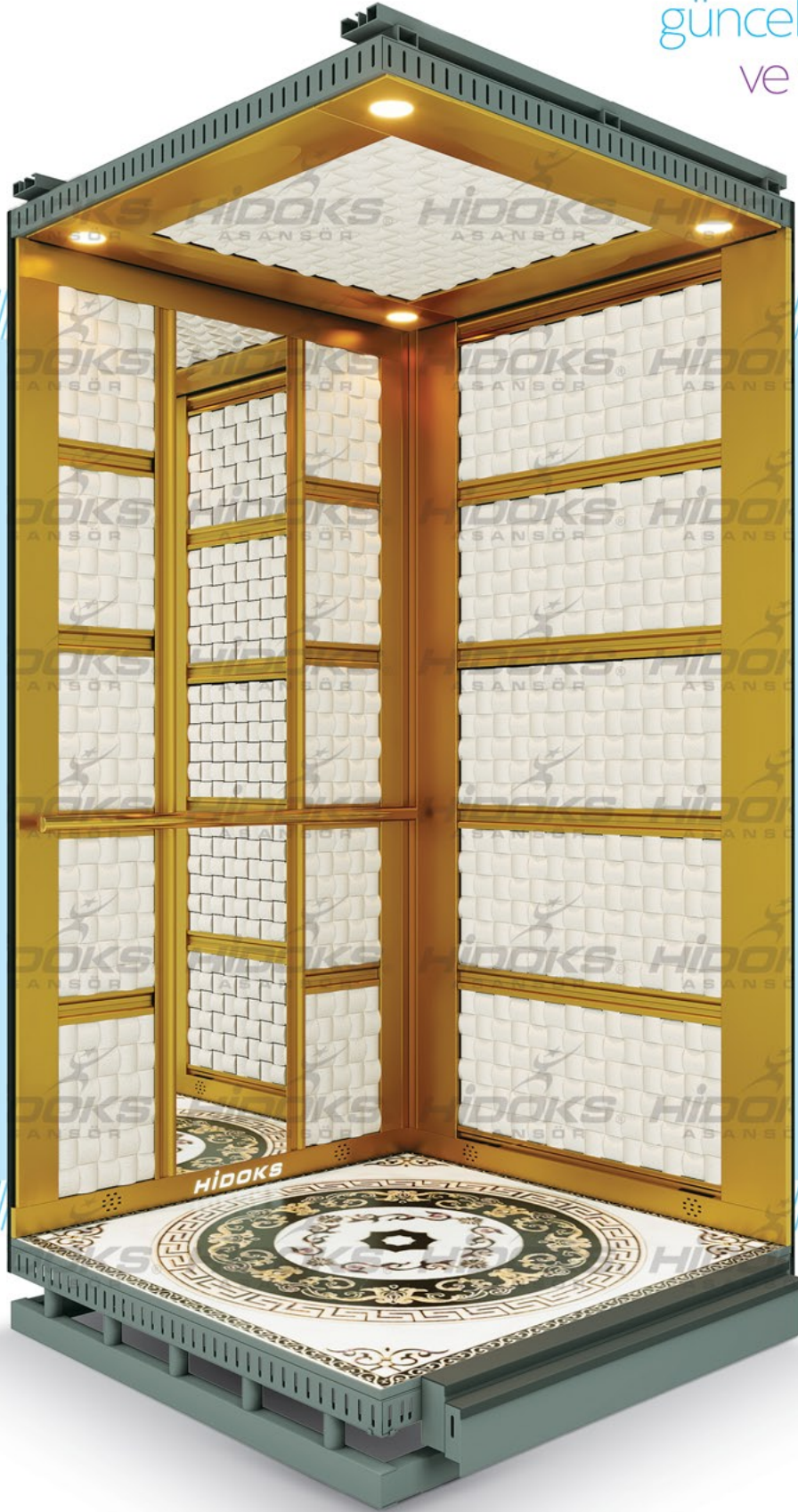

## BERLINO

Kabinler aydınlatma ve havalandırma sistemleri ile donatılmıştır.

Cabins equipped by lighting and ventilation systems.

Освещение кабин и оснащён вентиляционными системами.

مجھرة قیاسیا بأنظمة الانارة و التهوية و فرامل الأمان



TSEK ISO EAC CE

TAVAN | CEILING | ПОТОЛОК | سقف



Doğal Taş  
Natural Stone  
Природный Камень  
حجر طبيعي

DUVAR | WALL | СТЕНА | جدار



Doğal Taş  
Natural Stone  
Природный Камень  
حجر طبيعي

TABAN | FLOOR | БАЗА | الأرضية



Seramik  
Ceramic  
Керамический  
السيراميك



up to date technology  
and experience...

## OKASO

Kabinler aydınlatma ve havalandırma sistemleri ile donatılmıştır.

Cabins equipped by lighting and ventilation systems.

Освещение кабин и оснащён вентиляционными системами.

مجهرة قياسية بأنظمة الإنارة و التهوية و فرامل الأمان

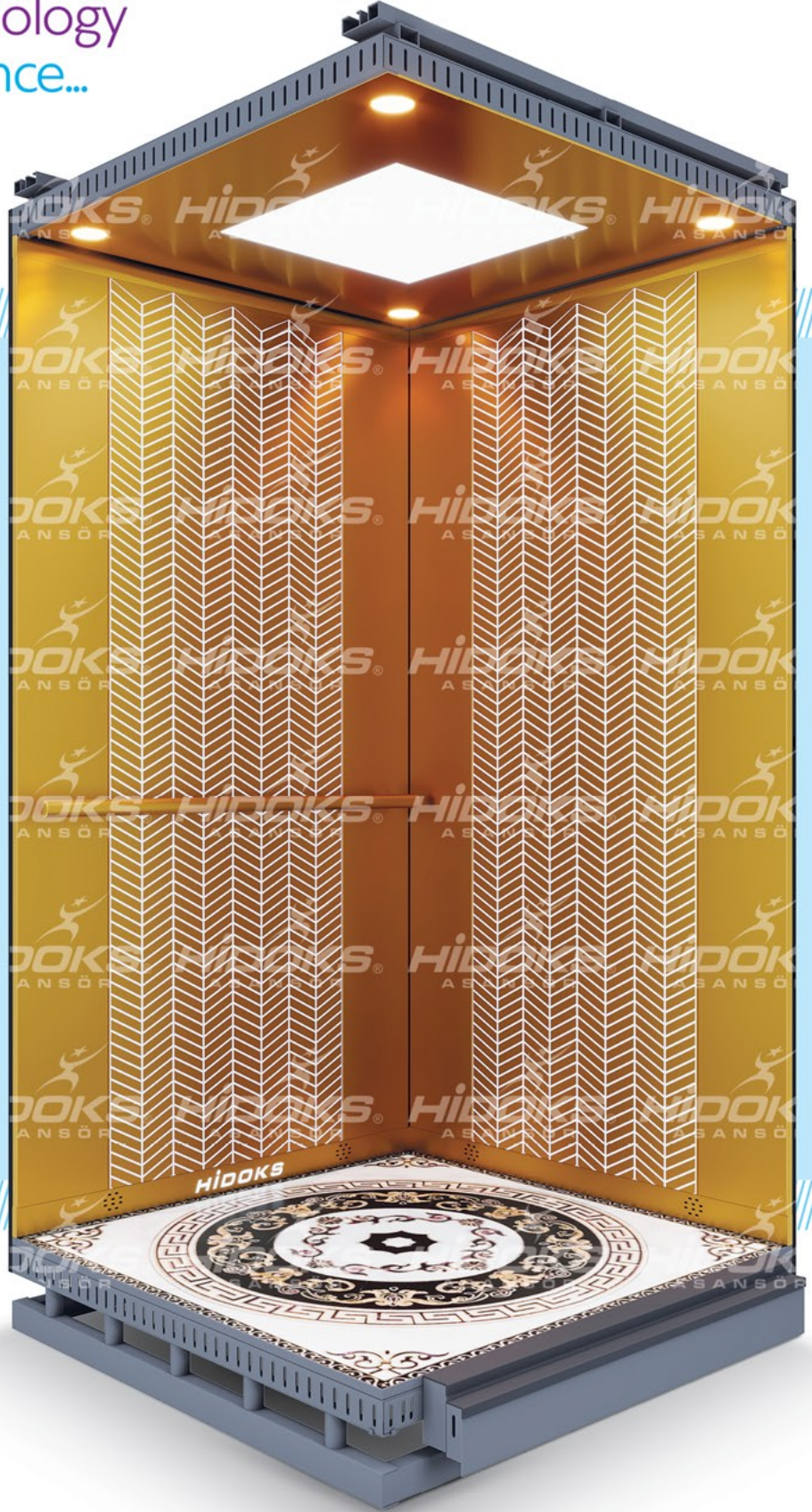

TSEK ISO EAC CE

TAVAN | CEILING | ПОТОЛОК | سقف



Lazer Kesim  
Laser Drawing  
Лазерная Резка  
القطع بالليزر

DUVAR | WALL | СТЕНА | جدار



Paslanmaz Sac  
Stainless Steel Sheet  
Нержавеющая Сталь  
صفائح الفولاذ المقاوم للصدأ

TABAN | FLOOR | БАЗА | الأرضية



Seramik  
Ceramic  
Керамический  
السيراميك



güncel teknolojiler  
ve tecrübemizle...



## VALOR

Kabinler aydınlatma ve havalandırma sistemleri ile donatılmıştır.

Cabins equipped by lighting and ventilation systems.

Освещение кабин и оснащён вентиляционными системами.

مجھرة قیاسیا بأنظمة الانارة و التهوية و فرامل الأمان



TSEK ISO EAC CE

TAVAN | CEILING | ПОТОЛОК | سقف



Lazer Kesim  
Laser Drawing  
Лазерная Резка  
القطع بالليزر

DUVAR | WALL | СТЕНА | جدار



Paslanmaz Sac  
Stainless Steel Sheet  
Нержавеющая Сталь  
صفائح الفولاذ المقاوم للصدأ

TABAN | FLOOR | БАЗА | الأرضية



Cam Baskı  
Glass Printing  
Печать На Стекле  
طباعة الزجاج



up to date technology  
and experience...

## BORNEO

Kabinler aydınlatma ve havalandırma sistemleri ile donatılmıştır.

Cabins equipped by lighting and ventilation systems.

Освещение кабин и оснащен вентиляционными системами.

مجهره قياسية بأنظمة الإنارة و التهوية و فرامل الأمان



TAVAN | CEILING | ПОТОЛОК | سقف



Lazer Kesim  
Laser Drawing  
Лазерная Резка  
القطع بالليزر

DUVAR | WALL | СТЕНА | جدار



Paslanmaz Sac  
Stainless Steel Sheet  
Нержавеющая Сталь  
صفائح الفولاذ المقاوم للصدأ

TABAN | FLOOR | БАЗА | الأرضية



PVC  
PVC  
ПВХ  
البلاستيكية



güncel teknolojiler  
ve tecrübemizle...



## DANTE

Kabinler aydınlatma ve havalandırma sistemleri ile donatılmıştır.

Cabins equipped by lighting and ventilation systems.

Освещение кабин и оснащён вентиляционными системами.

مجھرة قیاسیا بأنظمة الانارة و التهوية و فرامل الأمان



TSEK ISO EAC CE

TAVAN | CEILING | ПОТОЛОК | سقف



Lazer Kesim  
Laser Drawing  
Лазерная Резка  
القطع بالليزر

DUVAR | WALL | СТЕНА | جدار



Ahşap  
Wooden  
Деревянный  
ألواح خشبية

TABAN | FLOOR | БАЗА | الأرضية



Cam Baskı  
Glass Printing  
Печать На Стекле  
طباعة الزجاج



up to date technology  
and experience...

## VALENTE

Kabinler aydınlatma ve havalandırma sistemleri ile donatılmıştır.

Cabins equipped by lighting and ventilation systems.

Освещение кабин и оснащен вентиляционными системами.

مجهرة قياسية بأنظمة الإنارة و التهوية و فرامل الأمان



TAVAN | CEILING | ПОТОЛОК | سقف



Lazer Kesim  
Laser Drawing  
Лазерная Резка  
القطع بالليزر

DUVAR | WALL | СТЕНА | جدار



Laminant  
Laminat  
Ламинат  
الخشاب

TABAN | FLOOR | БАЗА | الأرضية



Doğal Granit  
Natural Granite  
Натуральный Гранит  
الجرانيت الطبيعي



güncel teknolojiler  
ve tecrübemizle...



## BRANDO

Kabinler aydınlatma ve havalandırma sistemleri ile donatılmıştır.

Cabins equipped by lighting and ventilation systems.

Освещение кабин и оснащён вентиляционными системами.

مجھرة قیاسیا بأنظمة الانارة و التهوية و فرامل الأمان



TSEK ISO EAC CE

TAVAN | CEILING | ПОТОЛОК | سقف



Lazer Kesim  
Laser Drawing  
Лазерная Резка  
القطع بالليزر

DUVAR | WALL | СТЕНА | جدار



Laminant  
Laminate  
Ламинат  
الخشاب

TABAN | FLOOR | БАЗА | الأرضية



Doğal Granit  
Natural Granite  
Натуральный Гранит  
الجرانيت الطبيعي



up to date technology  
and experience...

## SILVANO

Kabinler aydınlatma ve havalandırma sistemleri ile donatılmıştır.

Cabins equipped by lighting and ventilation systems.

Освещение кабин и оснащен вентиляционными системами.

مجهرة قياسية بأنظمة الإنارة و التهوية و فرامل الأمان



TAVAN | CEILING | ПОТОЛОК | سقف



Lazer Kesim  
Laser Drawing  
Лазерная Резка  
القطع بالليزر

DUVAR | WALL | СТЕНА | جدار



Paslanmaz Sac  
Stainless Steel Sheet  
Нержавеющая Сталь  
صفائح الفولاذ المقاوم للصدأ

TABAN | FLOOR | БАЗА | الأرضية



Doğal Granit  
Natural Granite  
Натуральный Гранит  
الجرانيت الطبيعي



güncel teknolojiler  
ve tecrübemizle...



## ROSIA

Kabinler aydınlatma ve havalandırma sistemleri ile donatılmıştır.

Cabins equipped by lighting and ventilation systems.

Освещение кабин и оснащён вентиляционными системами.

مجھرة قیاسیا بأنظمة الانارة و التهوية و فرامل الأمان



TSEK ISO EAC CE

TAVAN | CEILING | ПОТОЛОК | سقف



Lazer Kesim  
Laser Drawing  
Лазерная Резка  
القطع بالليزر

DUVAR | WALL | СТЕНА | جدار



Paslanmaz Sac  
Stainless Steel Sheet  
Нержавеющая Сталь  
صفائح الفولاذ المقاوم للصدأ

TABAN | FLOOR | БАЗА | الأرضية



Doğal Granit  
Natural Granite  
Натуральный Гранит  
الجرانيت الطبيعي



up to date technology  
and experience...

## RAYO

Kabinler aydınlatma ve havalandırma sistemleri ile donatılmıştır.

Cabins equipped by lighting and ventilation systems.

Освещение кабин и оснащен вентиляционными системами.

مجهره قیاسیا بأنظمة الإنارة و التهوية و فرامل الأمان



TAVAN | CEILING | ПОТОЛОК | سقف



Lazer Kesim  
Laser Drawing  
Лазерная Резка  
القطع بالليزر

DUVAR | WALL | СТЕНА | جدار



Paslanmaz Sac  
Stainless Steel Sheet  
Нержавеющая Сталь  
صفائح الفولاذ المقاوم للصدأ

TABAN | FLOOR | БАЗА | الأرضية



Doğal Granit  
Natural Granite  
Натуральный Гранит  
الجرانيت الطبيعي



güncel teknolojiler  
ve tecrübemizle...



## COLINA

Kabinler aydınlatma ve havalandırma sistemleri ile donatılmıştır.

Cabins equipped by lighting and ventilation systems.

Освещение кабин и оснащён вентиляционными системами.

مجھرة قیاسیا بأنظمة الانارة و التهوية و فرامل الأمان



TSEK ISO EAC CE

TAVAN | CEILING | ПОТОЛОК | سقف



Lazer Kesim  
Laser Drawing  
Лазерная Резка  
القطع بالليزر

DUVAR | WALL | СТЕНА | جدار



Paslanmaz Sac  
Stainless Steel Sheet  
Нержавеющая Сталь  
صفائح الفولاذ المقاوم للصدأ

TABAN | FLOOR | БАЗА | الأرضية



Doğal Granit  
Natural Granite  
Натуральный Гранит  
الجرانيت الطبيعي



up to date technology  
and experience...

## ARUBA

Kabinler aydınlatma ve havalandırma sistemleri ile donatılmıştır.

Cabins equipped by lighting and ventilation systems.

Освещение кабин и оснащен вентиляционными системами.

مجهره قیاسیا بأنظمة الإنارة و التهوية و فرامل الأمان



TAVAN | CEILING | ПОТОЛОК | سقف



Lazer Kesim  
Laser Drawing  
Лазерная Резка  
القطع بالليزر

DUVAR | WALL | СТЕНА | جدار



Paslanmaz Sac  
Stainless Steel Sheet  
Нержавеющая Сталь  
صفائح الفولاذ المقاوم للصدأ

TABAN | FLOOR | БАЗА | الأرضية



PVC  
PVC  
ПВХ  
البلاستيكية



güncel teknolojiler  
ve tecrübemizle...



## AZOV

Kabinler aydınlatma ve havalandırma sistemleri ile donatılmıştır.

Cabins equipped by lighting and ventilation systems.

Освещение кабин и оснащён вентиляционными системами.

مجھرة قیاسیا بأنظمة الإضاءة و التهوية و فرامل الأمان



TSEK ISO EAC CE

TAVAN | CEILING | ПОТОЛОК | سقف



Lazer Kesim  
Laser Drawing  
Лазерная Резка  
القطع بالليزر

DUVAR | WALL | СТЕНА | جدار



Paslanmaz Sac  
Stainless Steel Sheet  
Нержавеющая Сталь  
صفائح الفولاذ المقاوم للصدأ

TABAN | FLOOR | БАЗА | الأرضية



Doğal Granit  
Natural Granite  
Натуральный Гранит  
الجرانيت الطبيعي



up to date technology  
and experience...

## SIENA

Kabinler aydınlatma ve havalandırma sistemleri ile donatılmıştır.

Cabins equipped by lighting and ventilation systems.

Освещение кабин и оснащен вентилиационными системами.

مجهرة قياسية بأنظمة الإنارة و التهوية و فرامل الأمان



TAVAN | CEILING | ПОТОЛОК | سقف



Lazer Kesim  
Laser Drawing  
Лазерная Резка  
القطع بالليزر

DUVAR | WALL | СТЕНА | جدار



Paslanmaz Sac  
Stainless Steel Sheet  
Нержавеющая Сталь  
صفائح الفولاذ المقاوم للصدأ

TABAN | FLOOR | БАЗА | الأرضية



Doğal Granit  
Natural Granite  
Натуральный Гранит  
الجرانيت الطبيعي



güncel teknolojiler  
ve tecrübemizle...



## ADRINA

Kabinler aydınlatma ve havalandırma sistemleri ile donatılmıştır.

Cabins equipped by lighting and ventilation systems.

Освещение кабин и оснащён вентиляционными системами.

مجھرة قیاسیا بأنظمة الانارة و التهوية و فرامل الأمان



TSEK ISO EAC CE

TAVAN | CEILING | ПОТОЛОК | سقف



Lazer Kesim  
Laser Drawing  
Лазерная Резка  
القطع بالليزر

DUVAR | WALL | СТЕНА | جدار



Paslanmaz Sac  
Stainless Steel Sheet  
Нержавеющая Сталь  
صفائح الفولاذ المقاوم للصدأ

TABAN | FLOOR | БАЗА | الأرضية



Doğal Granit  
Natural Granite  
Натуральный Гранит  
الجرانيت الطبيعي



up to date technology  
and experience...

## MERLOT

Kabinler aydınlatma ve havalandırma sistemleri ile donatılmıştır.

Cabins equipped by lighting and ventilation systems.

Освещение кабин и оснащен  
вентиляционными системами.

مجهره قياسية بأنظمة الإنارة و التهوية و فرامل الأمان



TAVAN | CEILING | ПОТОЛОК | سقف



Lazer Kesim  
Laser Drawing  
Лазерная Резка  
القطع بالليزر

DUVAR | WALL | СТЕНА | جدار



Paslanmaz Sac  
Stainless Steel Sheet  
Нержавеющая Сталь  
صفائح الفولاذ المقاوم للصدأ

TABAN | FLOOR | БАЗА | الأرضية



Doğal Granit  
Natural Granite  
Натуральный Гранит  
الجرانيت الطبيعي



güncel teknolojiler  
ve tecrübemizle...



## CUBA

Kabinler aydınlatma ve havalandırma sistemleri ile donatılmıştır.

Cabins equipped by lighting and ventilation systems.

Освещение кабин и оснащён вентиляционными системами.

مجھرة قیاسیا بأنظمة الانارة و التهوية و فرامل الأمان



TSEK ISO EAC CE

TAVAN | CEILING | ПОТОЛОК | سقف



Lazer Kesim  
Laser Drawing  
Лазерная Резка  
القطع بالليزر

DUVAR | WALL | СТЕНА | جدار



Paslanmaz Sac  
Stainless Steel Sheet  
Нержавеющая Сталь  
صفائح الفولاذ المقاوم للصدأ

TABAN | FLOOR | БАЗА | الأرضية



Doğal Granit  
Natural Granite  
Натуральный Гранит  
الجرانيت الطبيعي



up to date technology  
and experience...

## ADEN

Kabinler aydınlatma ve havalandırma sistemleri ile donatılmıştır.

Cabins equipped by lighting and ventilation systems.

Освещение кабин и оснащен вентиляционными системами.

مجھرة قیاسیا بأنظمة الانارة و التهوية و فرامل الأمان

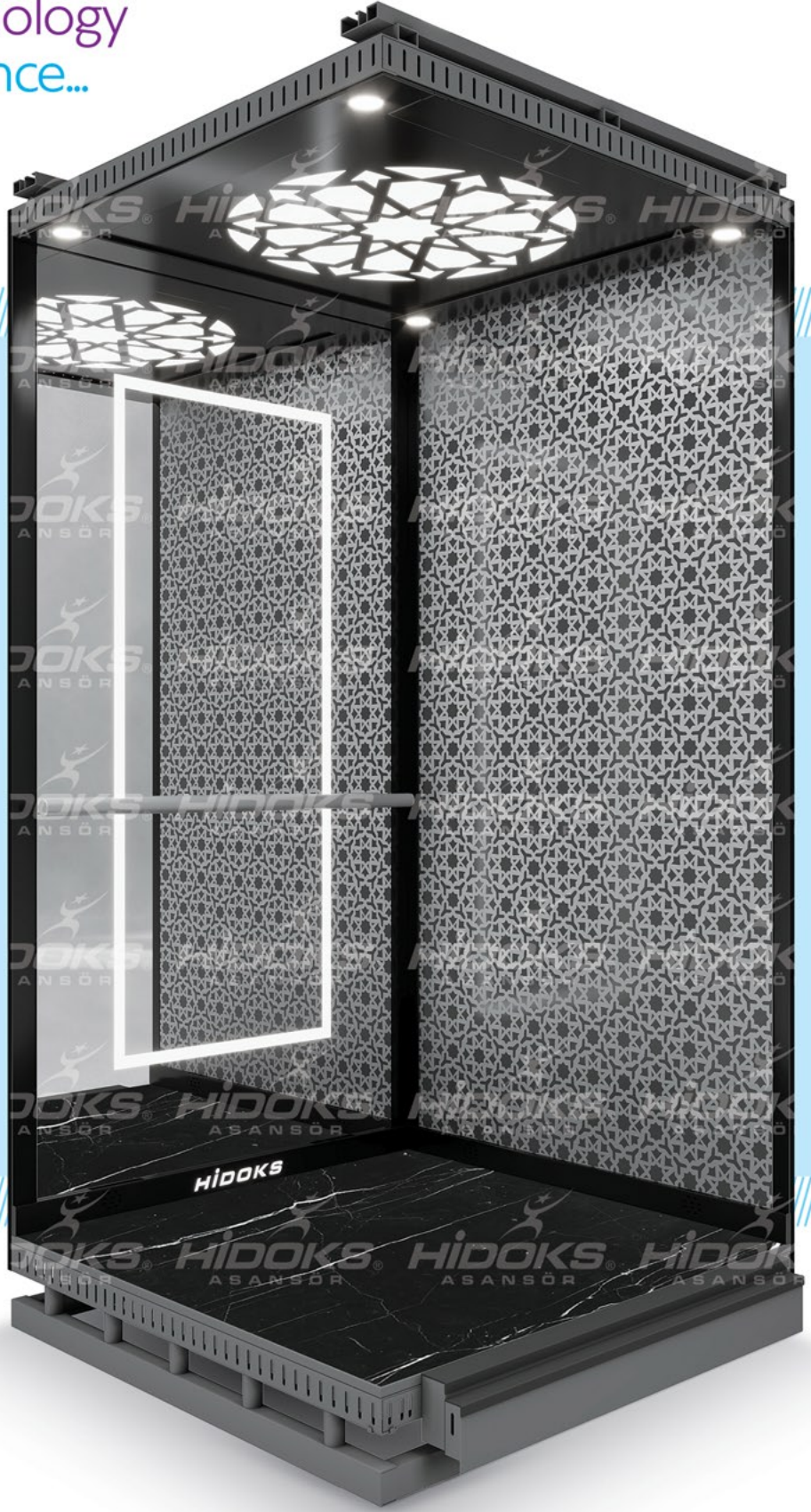

TAVAN | CEILING | ПОТОЛОК | سقف



Lazer Kesim  
Laser Drawing  
Лазерная Резка  
القطع بالليزر

DUVAR | WALL | СТЕНА | جدار



Paslanmaz Sac  
Stainless Steel Sheet  
Нержавеющая Сталь  
صفائح الفولاذ المقاوم للصدأ

TABAN | FLOOR | БАЗА | الأرضية



Doğal Granit  
Natural Granite  
Натуральный Гранит  
الجرانيت الطبيعي



güncel teknolojiler  
ve tecrübemizle...



## SULTAN

Kabinler aydınlatma ve havalandırma sistemleri ile donatılmıştır.

Cabins equipped by lighting and ventilation systems.

Освещение кабин и оснащён вентиляционными системами.

مجھرة قیاسیا بأنظمة الانارة و التهوية و فرامل الأمان



TSEK ISO EAC CE

TAVAN | CEILING | ПОТОЛОК | سقف



Lazer Kesim  
Laser Drawing  
Лазерная Резка  
القطع بالليزر

DUVAR | WALL | СТЕНА | جدار



Paslanmaz Sac  
Stainless Steel Sheet  
Нержавеющая Сталь  
صفائح الفولاذ المقاوم للصدأ

TABAN | FLOOR | БАЗА | الأرضية



Doğal Granit  
Natural Granite  
Натуральный Гранит  
الجرانيت الطبيعي



up to date technology  
and experience...

## CORDOBA

Kabinler aydınlatma ve havalandırma sistemleri ile donatılmıştır.

Cabins equipped by lighting and ventilation systems.

Освещение кабин и оснащён вентиляционными системами.

مجھرة قیاسیا بأنظمة الانارة و التهوية و فرامل الأمان



TSEK ISO EAC CE

TAVAN | CEILING | ПОТОЛОК | سقف



Laminant  
Laminate  
Ламинат  
الاخشاب

DUVAR | WALL | СТЕНА | جدار



Laminant  
Laminate  
Ламинат  
الاخشاب

TABAN | FLOOR | БАЗА | الأرضية



Doğal Granit  
Natural Granite  
Натуральный Гранит  
الجرانيت الطبيعي



güncel teknolojiler  
ve tecrübemizle...



## PATRIA

Kabinler aydınlatma ve havalandırma sistemleri ile donatılmıştır.

Cabins equipped by lighting and ventilation systems.

Освещение кабин и оснащён вентиляционными системами.

مجھرة قیاسیا بأنظمة الانارة و التهوية و فرامل الأمان



TAVAN | CEILING | ПОТОЛОК | سقف



Lazer Kesim  
Laser Drawing  
Лазерная Резка  
القطع بالليزر

DUVAR | WALL | СТЕНА | جدار



Laminant  
Laminate  
Ламинат  
الخشاب

TABAN | FLOOR | БАЗА | الأرضية



Doğal Granit  
Natural Granite  
Натуральный Гранит  
الجرانيت الطبيعي



up to date technology  
and experience...

## ARMA

Kabinler aydınlatma ve havalandırma sistemleri ile donatılmıştır.

Cabins equipped by lighting and ventilation systems.

Освещение кабин и оснащен вентиляционными системами.

مجهرة قياسية بأنظمة الإنارة و التهوية و فرامل الأمان



TAVAN | CEILING | ПОТОЛОК | سقف



Lazer Kesim  
Laser Drawing  
Лазерная Резка  
القطع بالليزر

DUVAR | WALL | СТЕНА | جدار



Ahşap  
Wooden  
Деревянный  
ألواح خشبية

TABAN | FLOOR | БАЗА | الأرضية



Doğal Granit  
Natural Granite  
Натуральный Гранит  
الجرانيت الطبيعي



güncel teknolojiler  
ve tecrübemizle...



## BANDERA

Kabinler aydınlatma ve havalandırma sistemleri ile donatılmıştır.

Cabins equipped by lighting and ventilation systems.

Освещение кабин и оснащён вентиляционными системами.

مجھرة قیاسیا بأنظمة الانارة و التهوية و فرامل الأمان



TSEK ISO EAC CE

TAVAN | CEILING | ПОТОЛОК | سقف



Lazer Kesim  
Laser Drawing  
Лазерная Резка  
القطع بالليزر

DUVAR | WALL | СТЕНА | جدار



Ahşap  
Wooden  
Деревянный  
ألواح خشبية

TABAN | FLOOR | БАЗА | الأرضية



PVC  
PVC  
ПВХ  
البلاستيكية



up to date technology  
and experience...

## PULSAR

Kabinler aydınlatma ve havalandırma sistemleri ile donatılmıştır.

Cabins equipped by lighting and ventilation systems.

Освещение кабин и оснащен  
вентиляционными системами.

مجهره قياسية بأنظمة الإنارة و التهوية و فرامل الأمان



TAVAN | CEILING | ПОТОЛОК | سقف



Lazer Kesim  
Laser Drawing  
Лазерная Резка  
القطع بالليزر

DUVAR | WALL | СТЕНА | جدار



Laminant  
Laminate  
Ламинат  
الإخشاب

TABAN | FLOOR | БАЗА | الأرضية



PVC  
PVC  
ПВХ  
البلاستيكية



güncel teknolojiler  
ve tecrübemizle...



## FRUTO

Kabinler aydınlatma ve havalandırma sistemleri ile donatılmıştır.

Cabins equipped by lighting and ventilation systems.

Освещение кабин и оснащён вентиляционными системами.

مجھرة قیاسیا بأنظمة الانارة و التهوية و فرامل الأمان



TAVAN | CEILING | ПОТОЛОК | سقف



Lazer Kesim  
Laser Drawing  
Лазерная Резка  
القطع بالليزر

DUVAR | WALL | СТЕНА | جدار



Laminant  
Laminate  
Ламинат  
الخشاب

TABAN | FLOOR | БАЗА | الأرضية



Doğal Granit  
Natural Granite  
Натуральный Гранит  
الجرانيت الطبيعي



up to date technology  
and experience...

## MONAKO

Kabinler aydınlatma ve havalandırma sistemleri ile donatılmıştır.

Cabins equipped by lighting and ventilation systems.

Освещение кабин и оснащен  
вентиляционными системами.

مجهرة قياسية بأنظمة الإنارة و التهوية و فرامل الأمان



TAVAN | CEILING | ПОТОЛОК | سقف



Lazer Kesim  
Laser Drawing  
Лазерная Резка  
القطع بالليزر

DUVAR | WALL | СТЕНА | جدار



Laminant  
Laminat  
Ламинат  
الاعشاب

TABAN | FLOOR | БАЗА | الأرضية



Doğal Granit  
Natural Granite  
Натуральный Гранит  
الجرانيت الطبيعي



güncel teknolojiler  
ve tecrübemizle...



## NOTA

Kabinler aydınlatma ve havalandırma sistemleri ile donatılmıştır.

Cabins equipped by lighting and ventilation systems.

Освещение кабин и оснащён вентиляционными системами.

مجھرة قیاسیا بأنظمة الانارة و التهوية و فرامل الأمان



TSEK ISO EAC CE

TAVAN | CEILING | ПОТОЛОК | سقف



Lazer Kesim  
Laser Drawing  
Лазерная Резка  
القطع بالليزر

DUVAR | WALL | СТЕНА | جدار



Laminant  
Laminate  
Ламинат  
الخشاب

TABAN | FLOOR | БАЗА | الأرضية



Doğal Granit  
Natural Granite  
Натуральный Гранит  
الجرانيت الطبيعي



up to date technology  
and experience...

## VERONA

Kabinler aydınlatma ve havalandırma sistemleri ile donatılmıştır.

Cabins equipped by lighting and ventilation systems.

Освещение кабин и оснащен вентилиационными системами.

مجھرة قیاسیا بأنظمة الانارة و النهوية و فرامل الأمان



TAVAN | CEILING | ПОТОЛОК | سقف



Lazer Kesim  
Laser Drawing  
Лазерная Резка  
القطع بالليزر

DUVAR | WALL | СТЕНА | جدار



Laminant  
Laminate  
Ламинат  
الاخشاب

TABAN | FLOOR | БАЗА | الأرضية



Doğal Granit  
Natural Granite  
Натуральный Гранит  
الجرانيت الطبيعي



güncel teknolojiler  
ve tecrübemizle...



## GRATIA

Kabinler aydınlatma ve havalandırma sistemleri ile donatılmıştır.

Cabins equipped by lighting and ventilation systems.

Освещение кабин и оснащён вентиляционными системами.

مجھرة قیاسیا بأنظمة الانارة و التهوية و فرامل الأمان



TSEK ISO EAC CE

TAVAN | CEILING | ПОТОЛОК | سقف



Lazer Kesim  
Laser Drawing  
Лазерная Резка  
القطع بالليزر

DUVAR | WALL | СТЕНА | جدار



Laminant  
Laminate  
Ламинат  
الخشاب

TABAN | FLOOR | БАЗА | الأرضية



Doğal Granit  
Natural Granite  
Натуральный Гранит  
الجرانيت الطبيعي



up to date technology  
and experience...

## AMOR

Kabinler aydınlatma ve havalandırma sistemleri ile donatılmıştır.

Cabins equipped by lighting and ventilation systems.

Освещение кабин и оснащен  
вентиляционными системами.

مجهرة قياسية بأنظمة الإنارة و التهوية و فرامل الأمان



TAVAN | CEILING | ПОТОЛОК | سقف



Lazer Kesim  
Laser Drawing  
Лазерная Резка  
القطع بالليزر

DUVAR | WALL | СТЕНА | جدار



Cam Baskı  
Glass Printing  
Печать На Стекле  
طباعة الزجاج

TABAN | FLOOR | БАЗА | الأرضية



Cam Baskı  
Glass Printing  
Печать На Стекле  
طباعة الزجاج



güncel teknolojiler  
ve tecrübemizle...



## CASTELO

Kabinler aydınlatma ve havalandırma sistemleri ile donatılmıştır.

Cabins equipped by lighting and ventilation systems.

Освещение кабин и оснащён вентиляционными системами.

مجھرة قیاسیا بأنظمة الانارة و التهوية و فرامل الأمان



TSEK ISO EAC CE

TAVAN | CEILING | ПОТОЛОК | سقف



Lazer Kesim  
Laser Drawing  
Лазерная Резка  
القطع بالليزر

DUVAR | WALL | СТЕНА | جدار



Cam Baskı  
Glass Printing  
Печать На Стекле  
طباعة الزجاج

TABAN | FLOOR | БАЗА | الأرضية



Cam Baskı  
Glass Printing  
Печать На Стекле  
طباعة الزجاج



up to date technology  
and experience...

## JOSE

Kabinler aydınlatma ve havalandırma sistemleri ile donatılmıştır.

Cabins equipped by lighting and ventilation systems.

Освещение кабин и оснащен вентиляционными системами.

مجھرة قیاسیا بأنظمة الإنارة و التهوية و فرامل الأمان



TAVAN | CEILING | ПОТОЛОК | سقف



Lazer Kesim  
Laser Drawing  
Лазерная Резка  
القطع بالليزر

DUVAR | WALL | СТЕНА | جدار



Cam Baskı  
Glass Printing  
Печать На Стекле  
طباعة الزجاج

TABAN | FLOOR | БАЗА | الأرضية



Cam Baskı  
Glass Printing  
Печать На Стекле  
طباعة الزجاج



güncel teknolojiler  
ve tecrübemizle...



## ASTRATO

Kabinler aydınlatma ve havalandırma sistemleri ile donatılmıştır.

Cabins equipped by lighting and ventilation systems.

Освещение кабин и оснащён вентиляционными системами.

مجھرة قیاسیا بأنظمة الانارة و التهوية و فرامل الأمان



TSEK ISO EAC CE

TAVAN | CEILING | ПОТОЛОК | سقف



Lazer Kesim  
Laser Drawing  
Лазерная Резка  
القطع بالليزر

DUVAR | WALL | СТЕНА | جدار



Cam Baskı  
Glass Printing  
Печать На Стекле  
طباعة الزجاج

TABAN | FLOOR | БАЗА | الأرضية



Cam Baskı  
Glass Printing  
Печать На Стекле  
طباعة الزجاج



up to date technology  
and experience...

## SANTOS

Kabinler aydınlatma ve havalandırma sistemleri ile donatılmıştır.

Cabins equipped by lighting and ventilation systems.

Освещение кабин и оснащен вентиляционными системами.

مجھرة قیاسیا بأنظمة الإنارة و التهوية و فرامل الأمان



TSEK ISO EAC CE

TAVAN | CEILING | ПОТОЛОК | سقف



Lazer Kesim  
Laser Drawing  
Лазерная Резка  
القطع بالليزر

DUVAR | WALL | СТЕНА | جدار



Cam Baskı  
Glass Printing  
Печать На Стекле  
طباعة الزجاج

TABAN | FLOOR | БАЗА | الأرضية



Cam Baskı  
Glass Printing  
Печать На Стекле  
طباعة الزجاج



güncel teknolojiler  
ve tecrübemizle...



## ANTİK

Kabinler aydınlatma ve havalandırma sistemleri ile donatılmıştır.

Cabins equipped by lighting and ventilation systems.

Освещение кабин и оснащён вентиляционными системами.

مجهرة قياسيا بأنظمة الانارة و التهوية و فرامل الأمان



TSEK ISO EAC CE

TAVAN | CEILING | ПОТОЛОК | سقف



Lazer Kesim  
Laser Drawing  
Лазерная Резка  
القطع بالليزر

DUVAR | WALL | СТЕНА | جدار



Cam Baskı  
Glass Printing  
Печать на стекле  
طباعة الزجاج

TABAN | FLOOR | БАЗА | الأرضية



PVC  
PVC  
ПВХ  
البلاستيكية



up to date technology  
and experience...



## Panoramik-1



## Panoramik-2







أبواب  
doors Двери  
kapılar

**fermator**  
AUTOMATIC DOORS FOR LIFTS

**HIDOOR HD**  
AUTOMATIC DOOR

**WITTUR**





**2 PANEL SAĞ TELESKOPIK**  
2 PANEL TELESCOPIC RIGHT  
2 ПАНЕЛЬ СПРАВА  
جانبي يمين ضلف عدد 2



**2 PANEL SOL TELESKOPIK**  
2 PANEL TELESCOPIC LEFT  
2 ПАНЕЛЬ СЛЕВА  
جانبي يسار ضلف عدد 2



**3 PANEL SAĞ TELESKOPIK**  
3 PANEL TELESCOPIC RIGHT  
3 ПАНЕЛЬ СПРАВА  
جانبي يمين ضلف عدد 3



**3 PANEL SOL TELESKOPIK**  
3 PANEL TELESCOPIC LEFT  
3 ПАНЕЛЬ СЛЕВА  
جانبي يسار ضلف عدد 3



**ÇERÇEVELİ CAM PANELİ**  
FRAMED GLASS PANEL  
РАМКА ИЗ СТЕКЛА  
ضلف زجاجية مع اطارات



**4 PANEL MERKEZİ**  
4 PANEL CENTRAL  
МЕХАНИЗМ ДВЕРИ КАБИНЫ ДВЕРЕЙ  
ЦЕНТРАЛЬНОГО ОТКРЫВАНИЯ  
مرکزي ضلف عدد 4



**6 PANEL MERKEZİ**  
6 PANEL CENTRAL  
МЕХАНИЗМ ДВЕРИ КАБИНЫ ДВЕРЕЙ  
ЦЕНТРАЛЬНОГО ОТКРЫВАНИЯ  
مرکزي ضلف عدد 6



RAL 1013



RAL 7032



RAL 9005



RAL 2004



RAL 3020



RAL 3005



RAL 6018



### 4 Panel Merkezi Kabin Mekanizması

Cabin Mechanism – 4 Panels  
Механизм двери шахты дверей центрального открывания  
باب الكابین - 4 ضلف

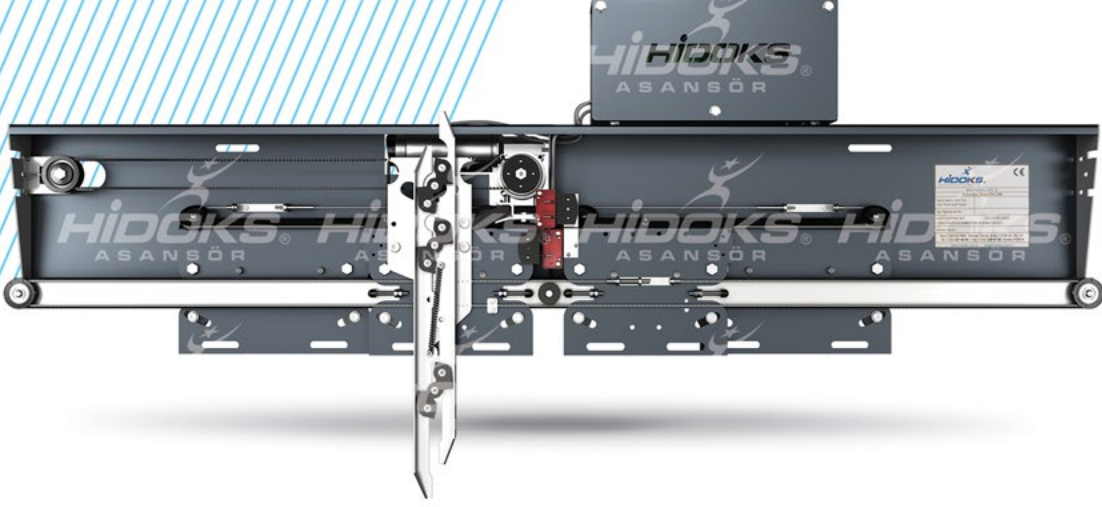

### 4 Panel Merkezi Kat Mekanizması

Landing Mechanism – 4 Panels  
Механизм двери кабины дверей центрального открывания  
باب الطابق - 4 ضلف

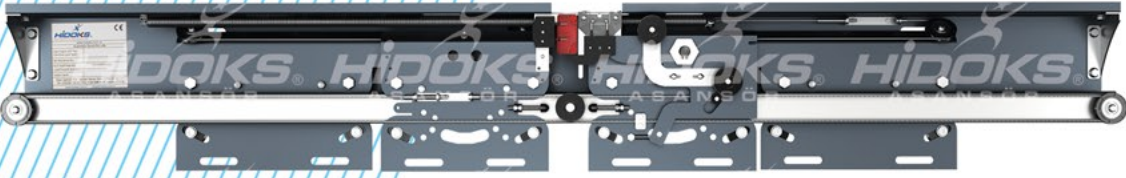

güncel teknolojiler  
ve tecrübemizle...

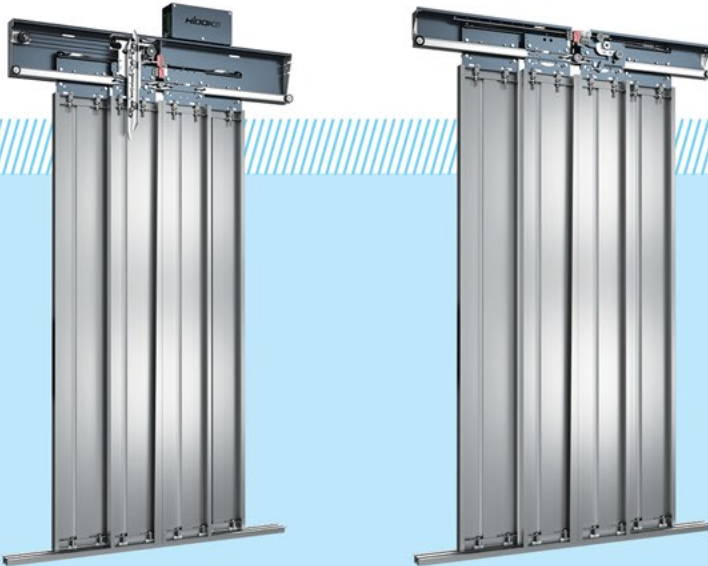

TSEK ISO EAC CE



Cabin Mechanism – 2 Panels  
Механизм двери шахты дверей центрального открывания  
باب الكابين – 2 ضلف

### 2 Panel Merkezi Kabin Mekanizması

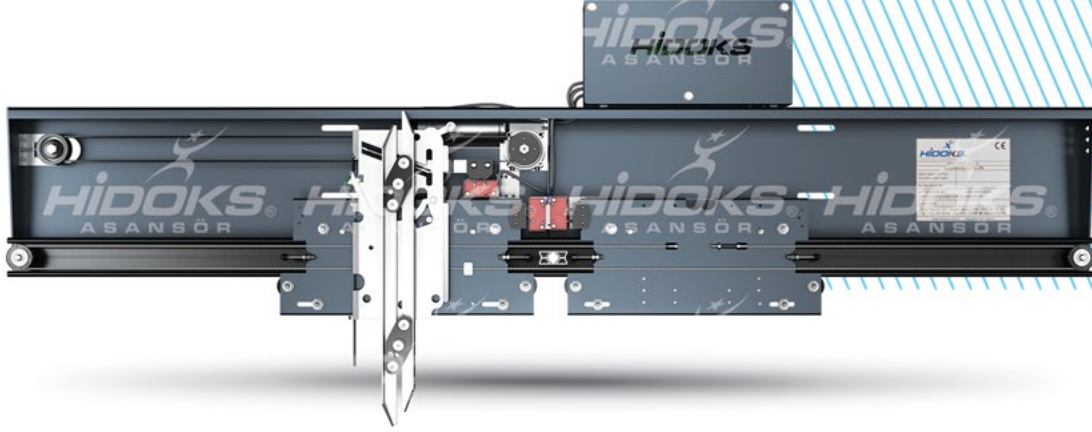

Landing Mechanism – 2 Panels  
Механизм двери кабины дверей центрального открывания  
باب الطابق – 2 ضلف

### 2 Panel Merkezi Kat Mekanizması

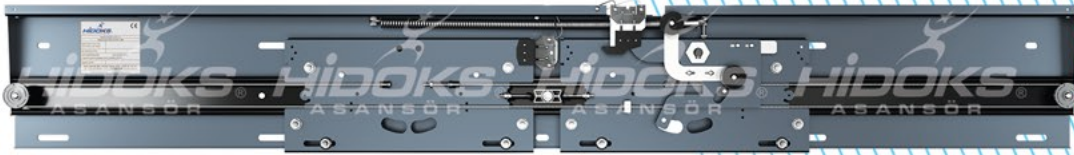

up to date **technology**  
and **experience...**

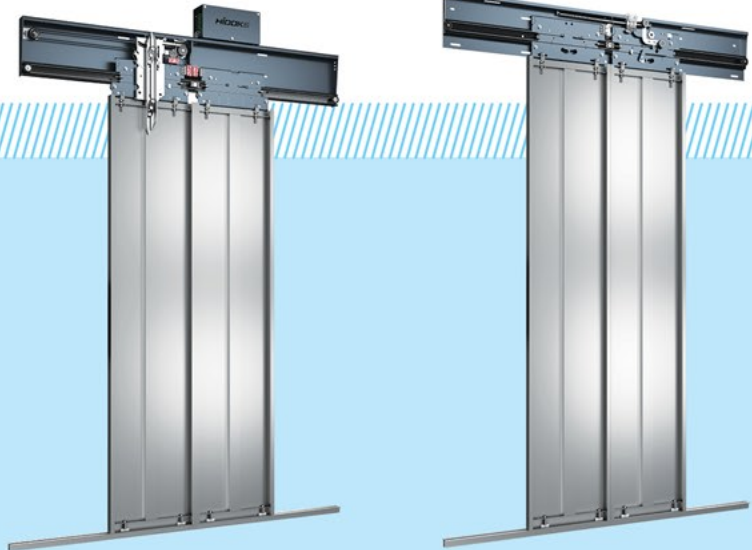

TSEK ISO EAC CE



### 3 Panel Teleskopik Kabin Paneli

Cabin Mechanism – 3 Panels

Автоматический механизм открывающаяся дверь (Телескопическа)

باب الكابين - 3 ضلف

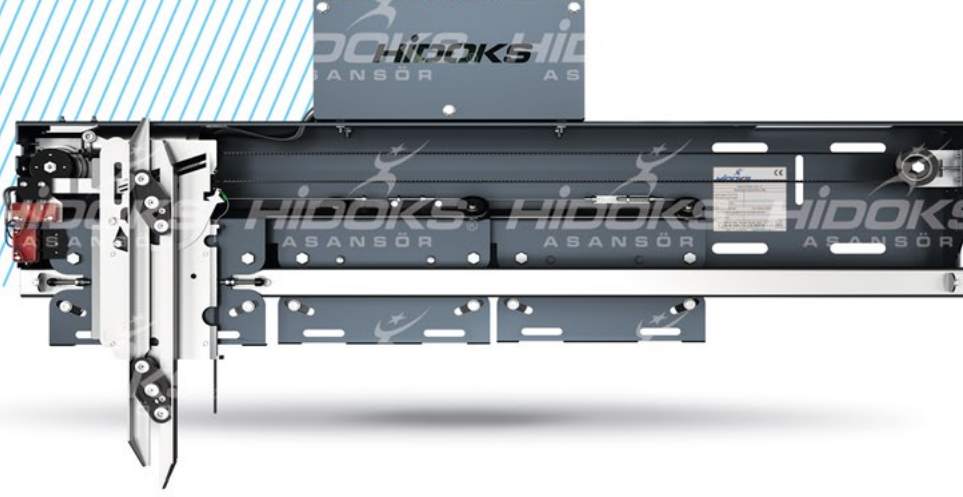

### 3 Panel Teleskopik Kat Paneli

Landing Mechanism – 3 Panels

Механизм автоматического открывания дверей (Телескопическа)

باب الطابق - 3 ضلف



güncel teknolojiler  
ve tecrübemizle...



TSEK ISO EAC CE



Cabin Mechanism – 2 Panels  
Автоматический механизм открывающаяся дверь (Телескопическа)  
باب الكابين - 2 ضلف

**2 Panel Teleskopik Kabin Paneli**



Landing Mechanism – 2 Panels  
Механизм автоматического открывания дверей (Телескопическа)  
باب الطابق - 2 ضلف

**2 Panel Teleskopik Kat Paneli**



up to date **technology**  
and **experience...**







HM01



HM02

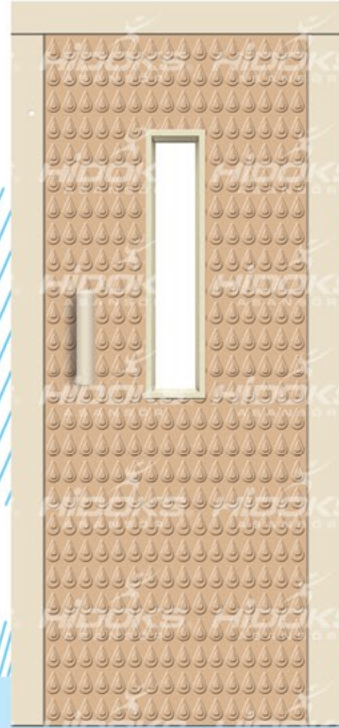

HM03



HM04



RAL 1013



RAL 7032



RAL 9005



RAL 2004



RAL 3020



RAL 3005



RAL 6018



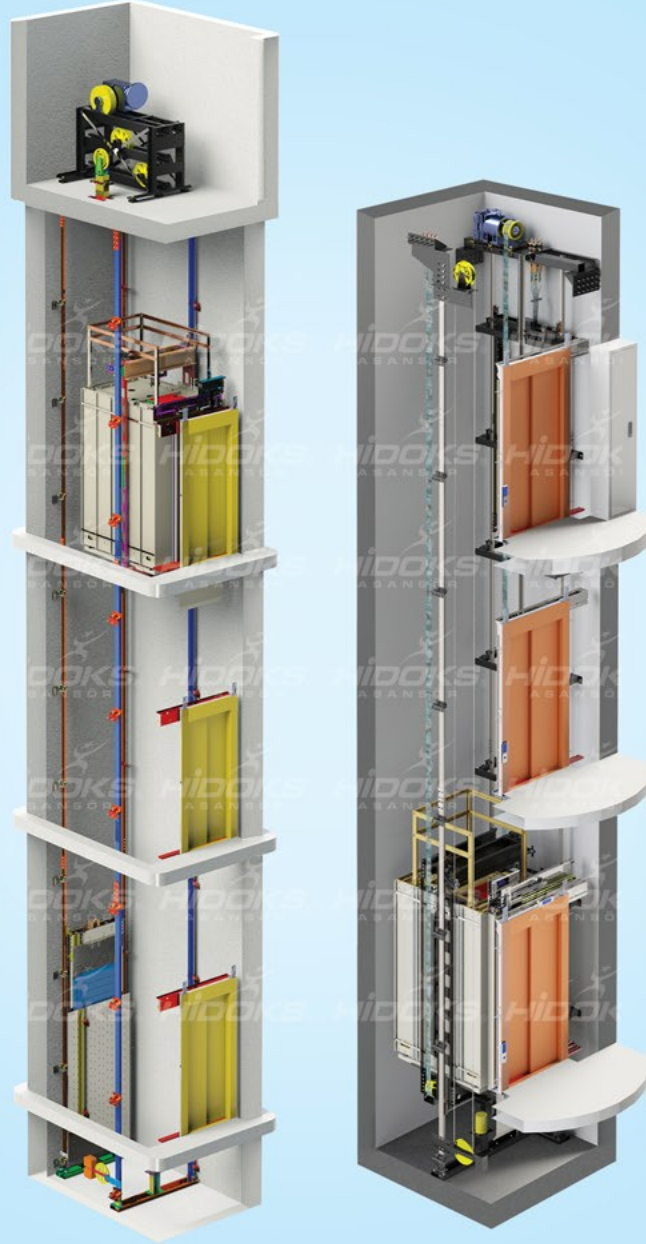

أنظمة التعليق шахта  
suspension types  
sistemler





KABIN SÜSPANSİYONLARI / CABIN SUSPENSIONS / ПОДВЕСКИ КАБИНЫ / تعليق الكابينة

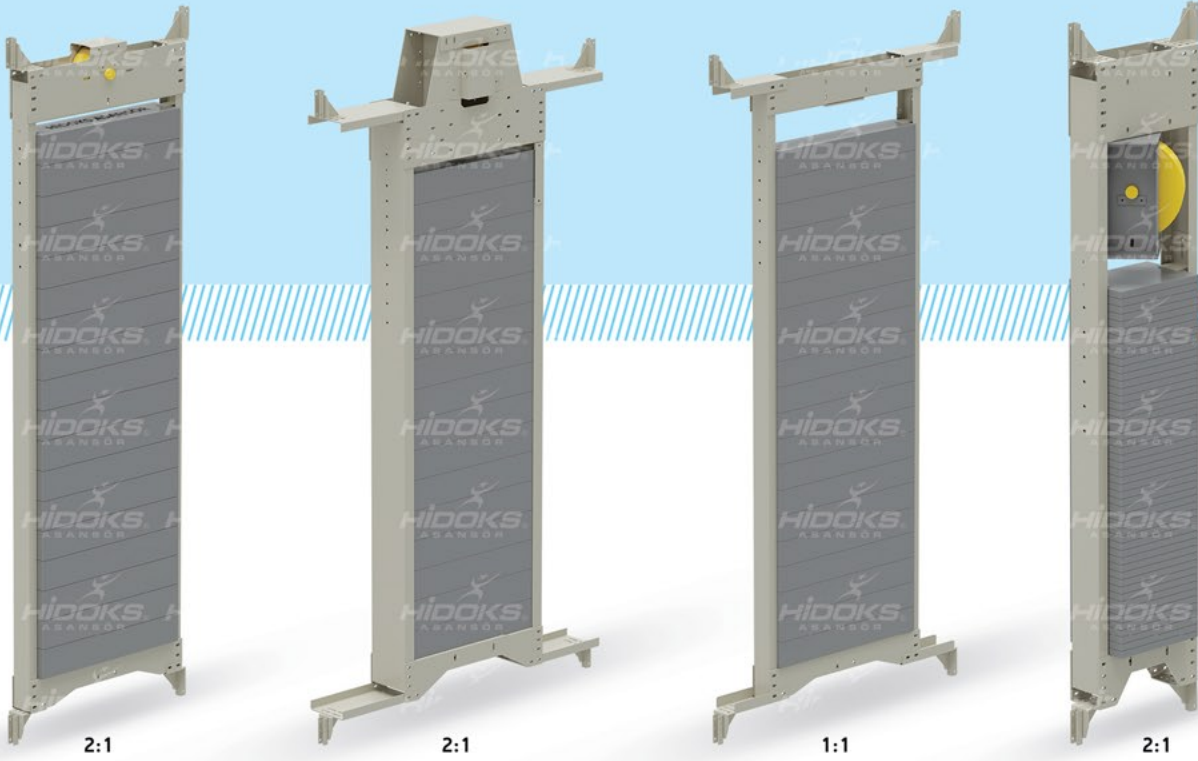

AĞIRLIK ŞASESİ / CW FRAME / ВЕС ШАССИ / هيكل الوزن



2:1 C KARKAS  
CARCASE 2:1 "C"  
КАРКАС КАБИНЫ 2:1 "С"  
تعليق ل



2:1 L KARKAS  
CARCASE 2:1 "L"  
КАРКАС КАБИНЫ 2:1 "L"  
تعليق ل



2:1 HIDROLİK KARKAS  
HYDRAULIC FRAME 2:1  
ГИДРАВЛИЧЕСКАЯ РАМА 2:1  
إطار هيدروليكي

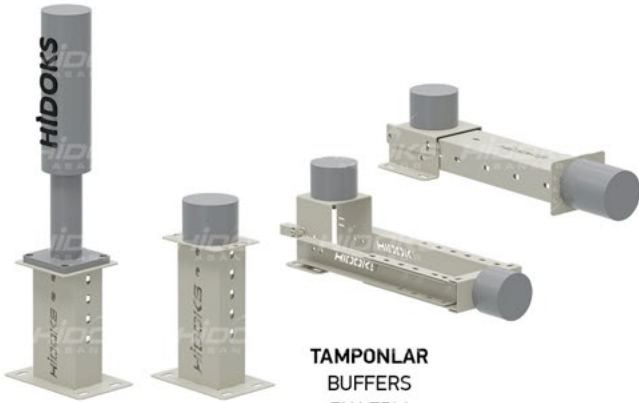

TAMPONLAR  
BUFFERS  
БУФЕРЫ  
مخمدات



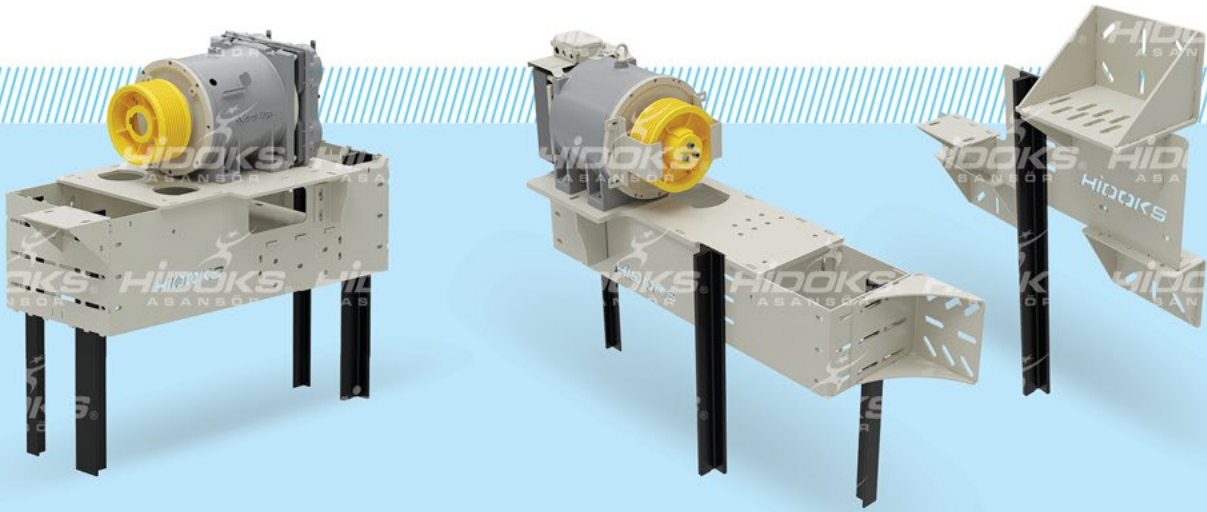

MAKİNE SEHPALARI / MACHINE BEDFRAME / МАШИННЫЕ СТЕНДЫ / قواعد المحركات

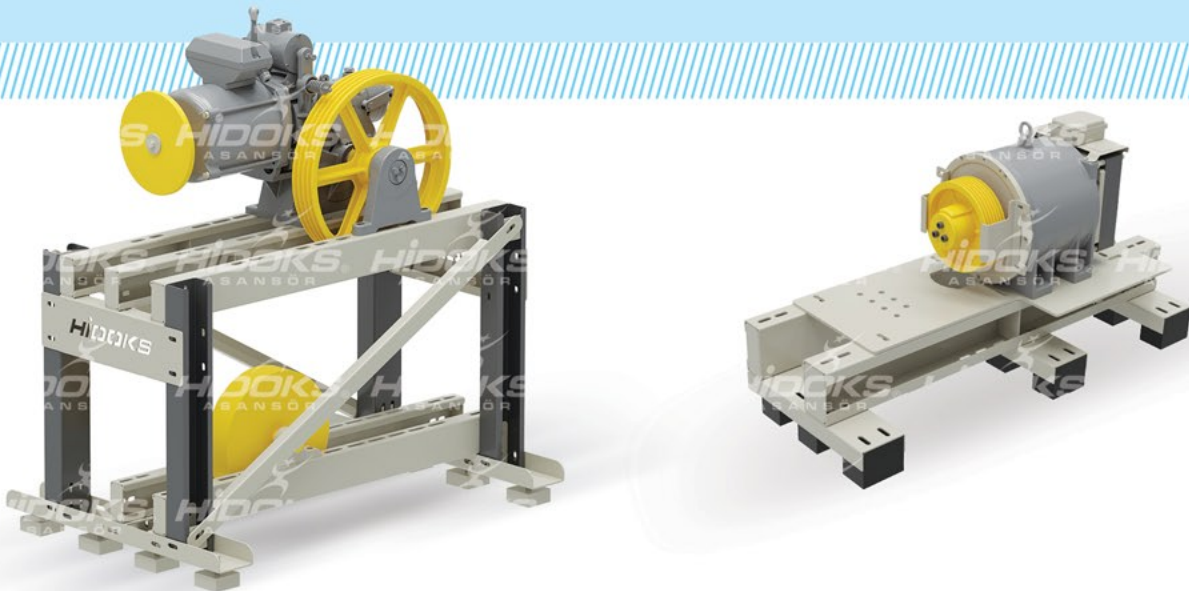



ÇELİK KONSTRÜKSİYONLAR / STEEL CONSTRUCTIONS / СТАЛЬНЫЕ КОНСТРУКЦИИ / الإنشاءات الفولاذية



**YUVARLAK MODEL**  
ROUND MODEL  
КРУГЛАЯ МОДЕЛЬ  
دائري



**STANDART MODEL**  
STANDARD MODEL  
СТАНДАРТНАЯ МОДЕЛЬ  
نموذج قياسي



**MONŞARJ MODEL**  
SERVICE MODEL  
СЕРВИСНАЯ МОДЕЛЬ  
مصاعد الطعام





**DİKEY TİP ENGELLİ PLATFORMU**  
VERTICAL TYPE DISABLED PLATFORM  
ПЛАТФОРМА ДЛЯ ИНВАЛИДОВ ВЕРТИКАЛЬНОГО ТИПА  
مصعد خارجي خاص بذوي الاحتياجات الخاصة



**KAPALI TİP ENGELLİ PLATFORMU**  
CLOSE TYPE DISABLED PLATFORM  
ПЛАТФОРМА ДЛЯ ИНВАЛИДОВ ЗАКРЫТОГО ТИПА  
مصاعد منزلية مغلقة



**MONŞARJ ASANSÖR**  
DUMBWAITER  
ФУД ЭЛЕВАТОР  
مصعد الطعام



**KOLTUK TİPİ ENGELLİ PLATFORM**  
STAIR LIFT  
БЛОКИРОВАННАЯ ПЛАТФОРМА ТИПА СИДЕНЬЯ  
مقعد متحرك مع الدرج



**MERDİVEN TİPİ ENGELLİ PLATFORMU**  
STAIRS TYPE DISABLED PLATFORM  
ПЛАТФОРМА ДЛЯ ИНВАЛИДОВ ЛЕСТНИЧНОГО ТИПА  
مصعد قابل للحركة مع الدرج



**MERDİVEN TIRMANICI**  
STAIR CLIMBER  
MERDİVEN ALPİNİST  
متسلق للدرج





**EV ASANSÖRÜ**  
HOMELIFT  
ДОМ ПОДЪЕМНИК  
مصاعد منزلية (هوم ليفت)



**ÇİFT TARAFLI HİDROLİK YÜK PLATFORMU**  
DOUBLE SIDED HYDRAULIC LOAD PLATFORM  
ДВУСТОРОННЯЯ ГИДРАВЛИЧЕСКАЯ НАГРУЗОЧНАЯ ПЛАТФОРМА  
منصة تحميل هيدروليكي مزدوجة الجوانب

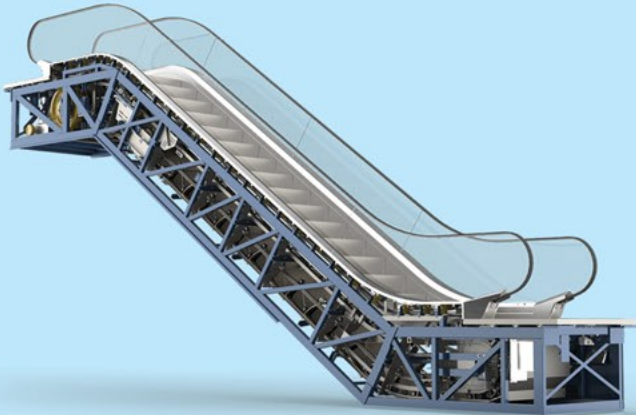

**YÜRÜYEN MERDİVEN**  
ESCALATOR  
ЭСКАЛАТОР  
درج متحرك



**ARAÇ ASANSÖRÜ**  
CAR LIFT  
АВТОПОДЪЕМНИК  
مصعد سيارة





لوحات الطلب كНОПКИ  
operating panels  
butonlar





U29TM0001

U21TM0001  
(TEMASSIZ)

U21TM0003

U21TM0013



U31YR0002

GALAXY

PENTA



U20SM0033

U20SM0022

U20SM0028



U20DB0008

U30DB0005

U30DB0005



PENTA

U20SM0002

U20SM0017

U20SM0018

U20SM0027  
TEMASSIZ



U30KU0001



U20KU0002



U20KU0004



U21YT0001





7325.M7VT



9315.DS2X



C.FSBG  
9315.DS2X



7215.DS2X



7215.DS2X



2002



30W0



1012



2012



AVAC-1002



AVAC-2002



AVAC-1012



AVAC-2072



4210



AVAC-4210





المحركات

traction machines лебедки

makine motorlar

**Dişli Sistemler**

GEARBOX MACHINE / ПЕРЕДАЧНЫЕ СИСТЕМЫ / مصعد جیربوكس

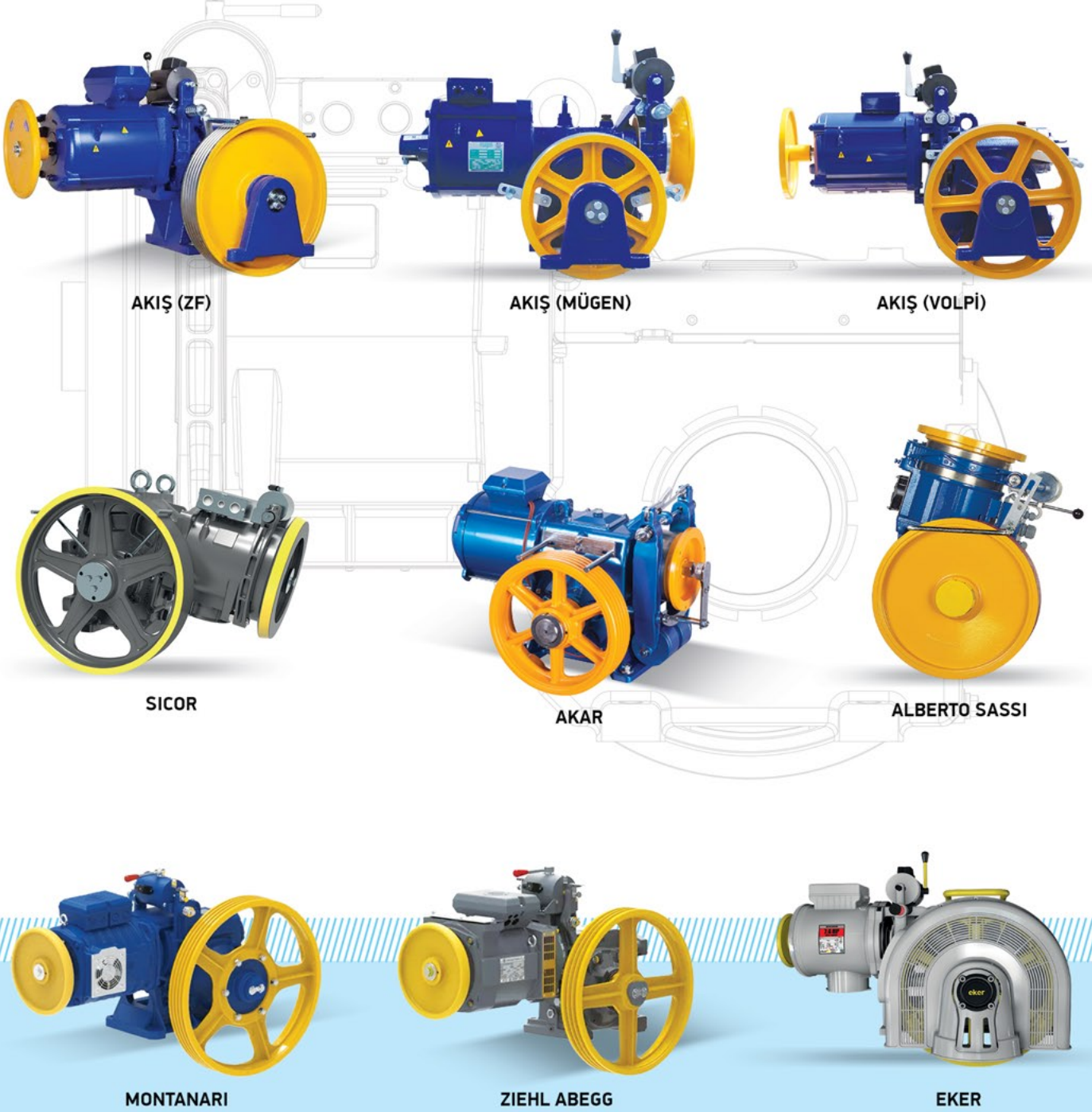



**Dişlisiz sistemler**

GEARLESS MACHINE / БЕЗРЕДУКТОРНЫЕ СИСТЕМЫ / محرك غيرلس



**AKIŞ**



**AKAR**



**EKER**

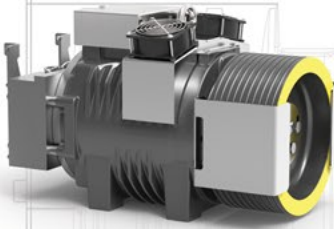

**SICOR**



**ZIEHL ABEGG**



**ALBERTO SASSI**



**MONTANARI**



**WITTUR**



**VOLARE**



لوحات التحكم    система  
control    управления  
panels    panolar





**Makine Dairesiz Sistemler İçin Kontrol Panosu (MRL)**  
Control Panel for Machine Roomless Systems (MRL)  
Щит Управления (Mrl) Для Систем Без Машинного Помещения  
کنترول مصعد غیرلس بدون غرفه محرك



**Seri Bağlantılı Revizyon Kutusu**  
Serial Inspection Box  
Блок Проверки Последовательного Соединения  
علبة الصيانة



**Makine Daireli Sistemler İçin Kontrol Panosu (MR)**  
Control Panel for Systems with Machine Room (MR)  
Панель Управления (Mr) Для Систем С Машинным Помещением  
کنترول مصعد غير عادي بغرفة محرك





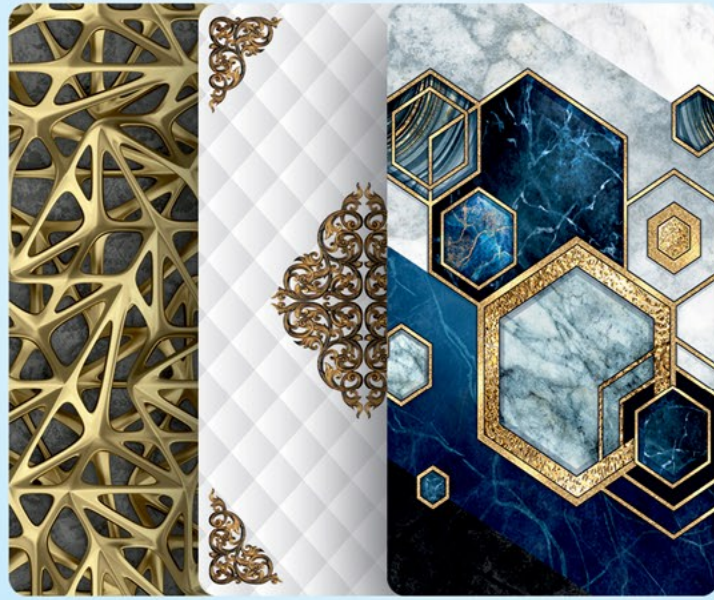

ملحقات

accessories аксессуары

aksesuarlar

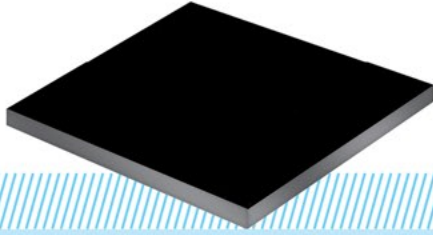

ABSOLUTE BLACK

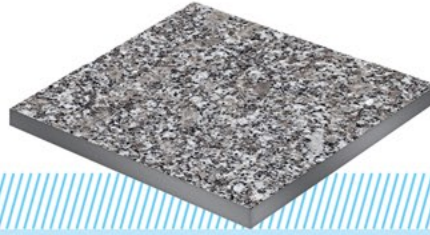

AKSARAY YAYLAK

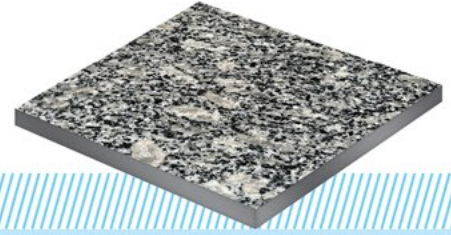

ANKARA FÜME

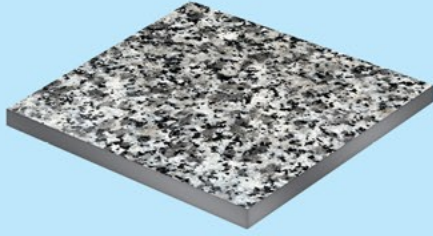

BIANCO PERLA

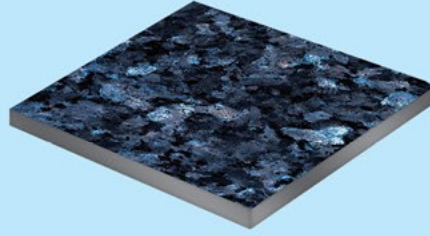

BLUE PEARL



DOLAMİT

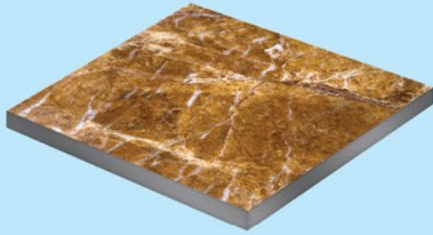

GOLDEN BRONZE

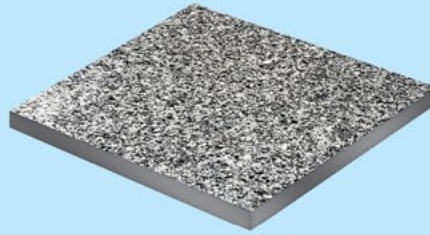

HİSAR GRİ



MELİSA BEJ

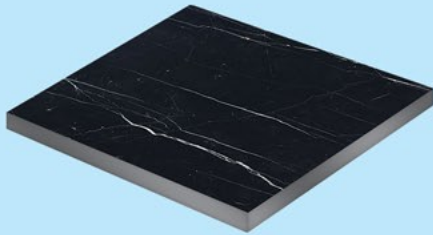

PASHA BLACK



ROSA MİNHÖ

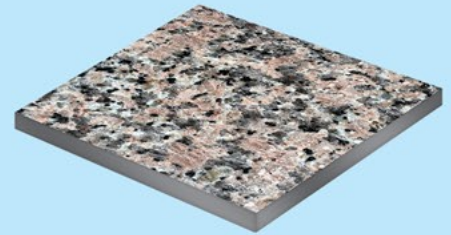

ROSA PORİNHÖ

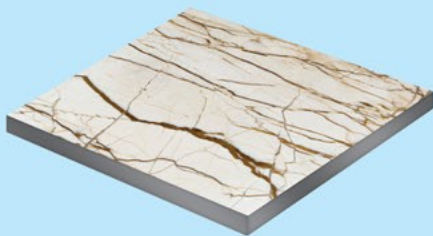

SOFİTA

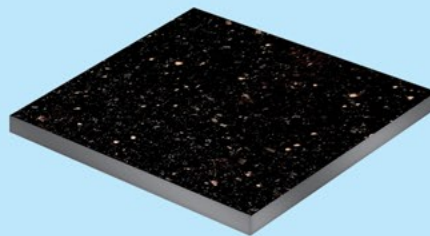

STAR GALAXY

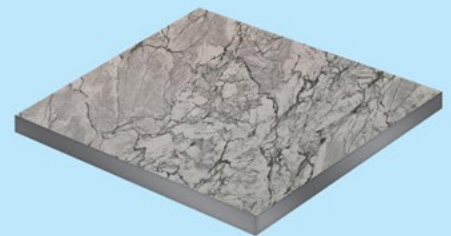

SUPREME WHITE

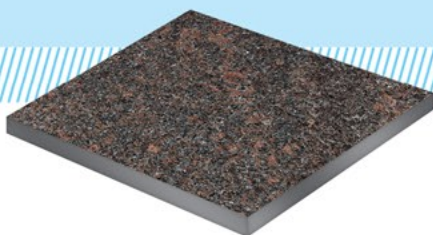

DAKOTA BROWN

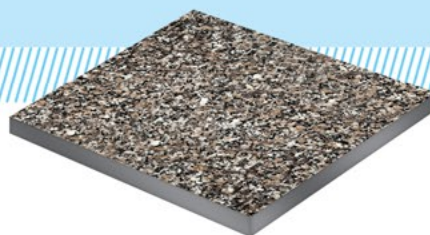

BERGAMA

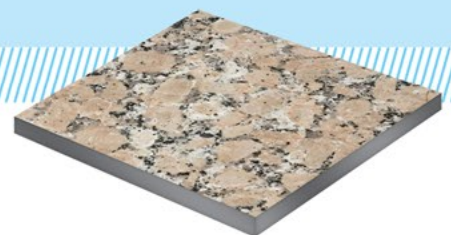

ROSAWEL





S1000

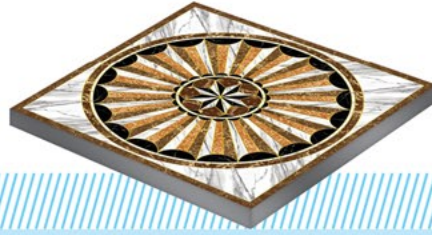

S1001



S1002



S1003



S1004



S1005



S1006



S1007

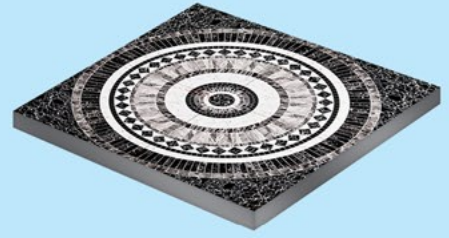

S1008



AEZ 148



AEZ 149

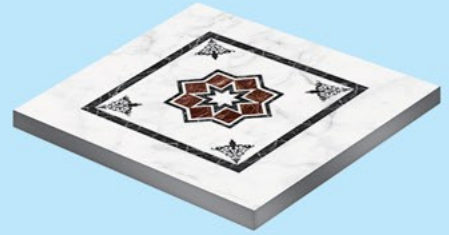

AEZ 150

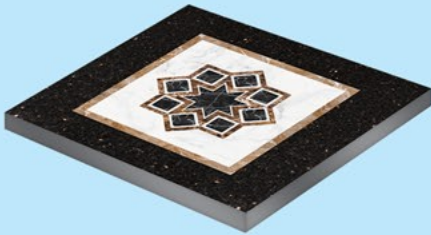

AEZ 151



AEZ 154



AEZ 156

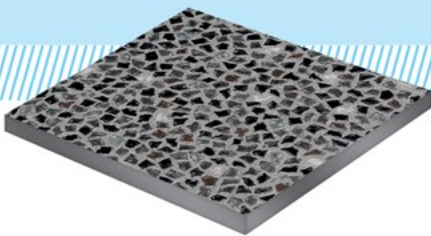

PVC 1

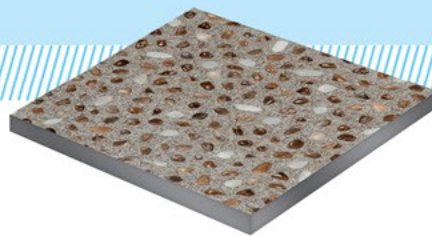

PVC 2

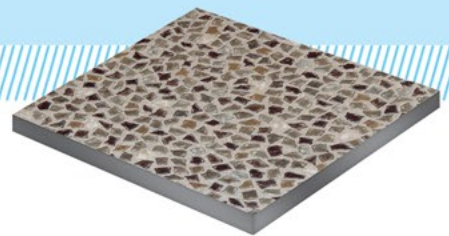

PVC 3





T1000

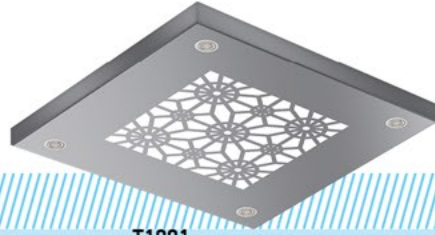

T1001



T1002



T1003



T1004

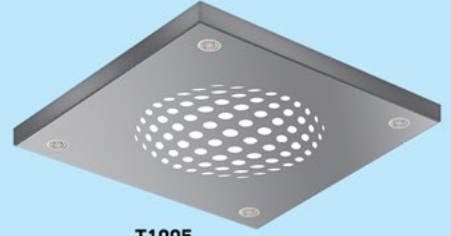

T1005



T1006



T1007



T1008



T1009



T1010



T1011



T1012



T1013



T1014



T1015



T1016

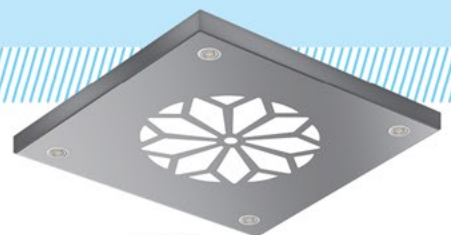

T1017



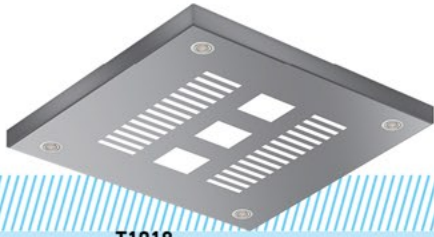

T1018

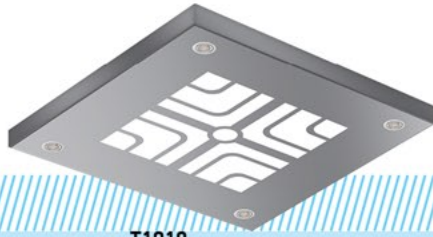

T1019



T1020



T1021



T1022



T1023

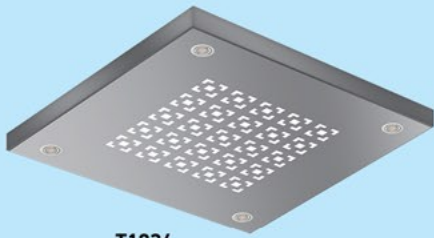

T1024



T1025

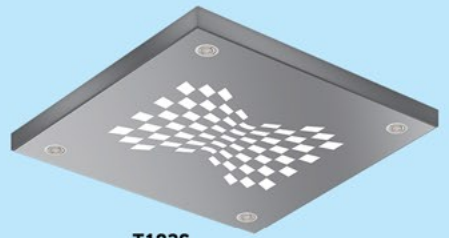

T1026



T1027



T1028



T1029



T1030



T1031



T1032



T1033

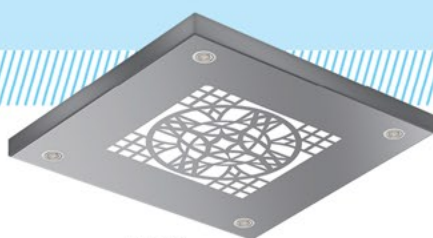

T1034



T1035





DV100



DV101



DV102



DV103



TB100

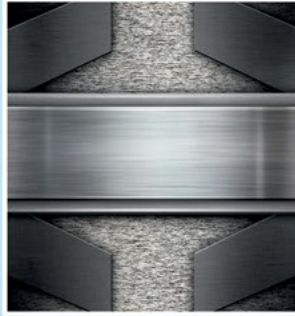

TB101



TB102



TB103



DV108

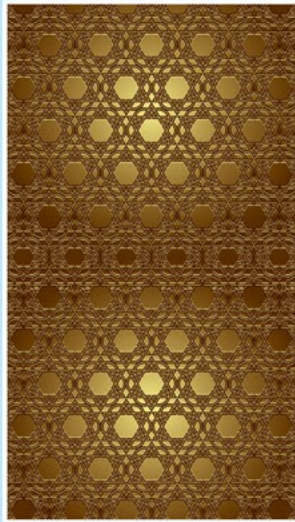

DV109

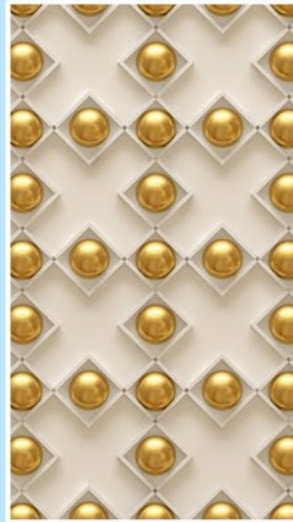

DV110

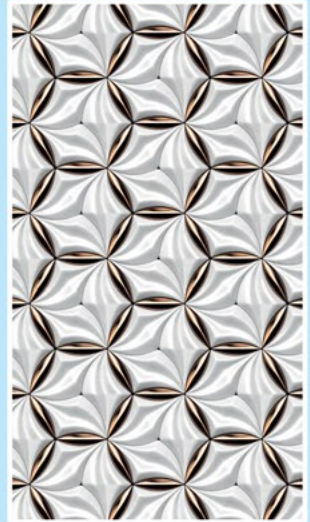

DV111



TB108



TB109



TB110

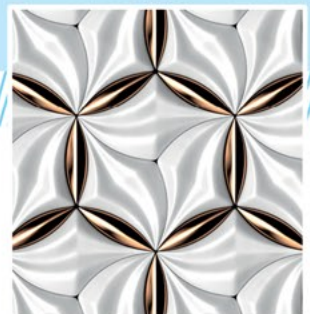

TB111





DV104



DV105

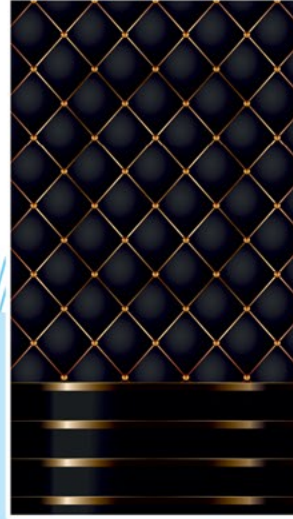

DV106

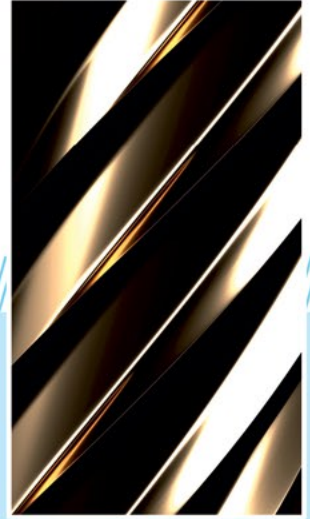

DV107



TB104



TB105



TB106

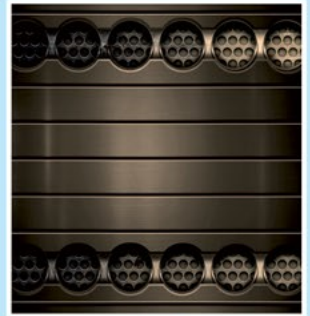

TB107



DV112

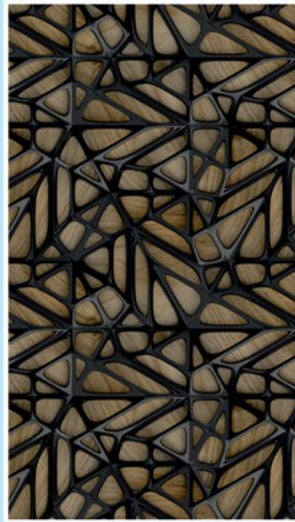

DV113

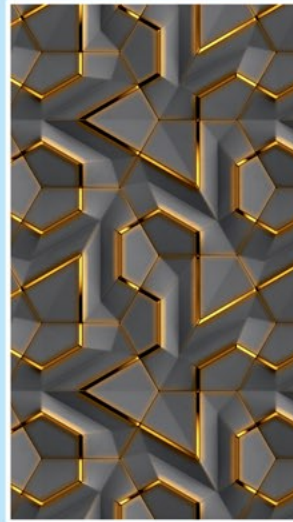

DV114



DV115



TB112



TB113

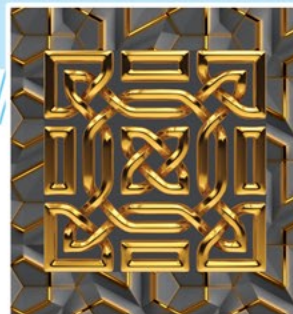

TB114



TB115



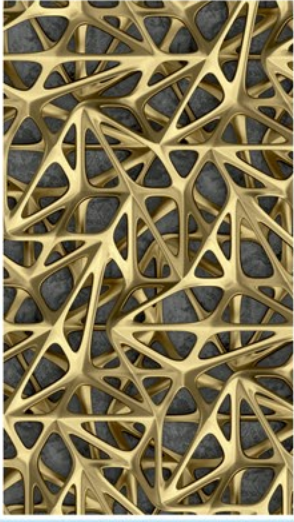

DV116



DV117

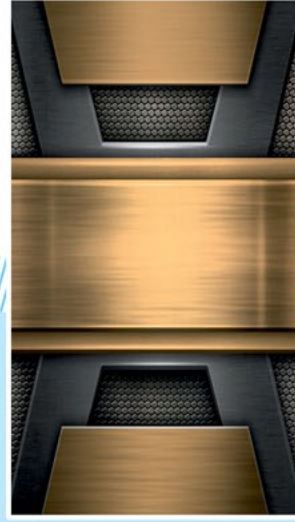

DV118



DV119



TB116

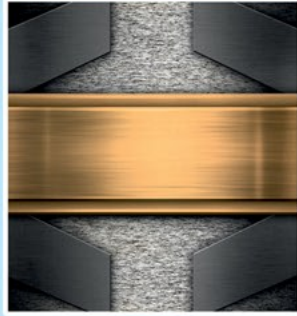

TB117

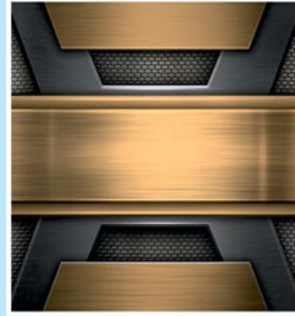

TB118



TB119



DV120

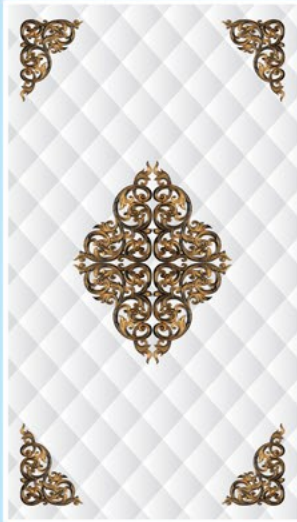

DV121

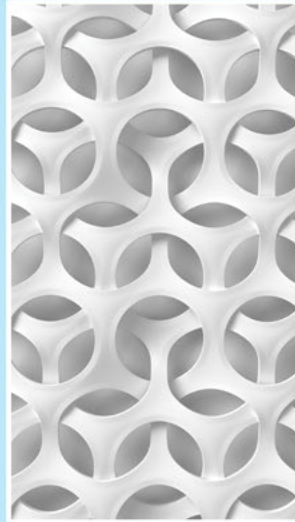

DV122



DV123



TB120



TB121



TB122

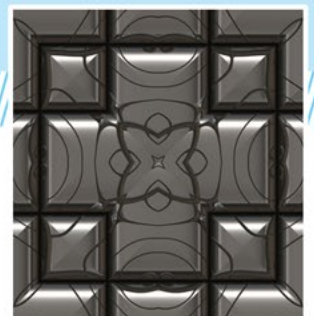

TB123





Boa Vista Teak



Yukon Oak



Mont Pelvoux Oak



Rhodes Teak



Cashel Oak



Orleans Oak



Ketchikan Oak



Banff Walnut



Kinsale Oak 4



Annapurna Teak



Caucasian Walnut



Mendoza Oak



8001

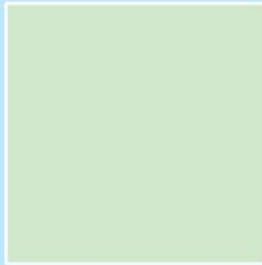

8002



8003



8004



8005



8006



8006



8006

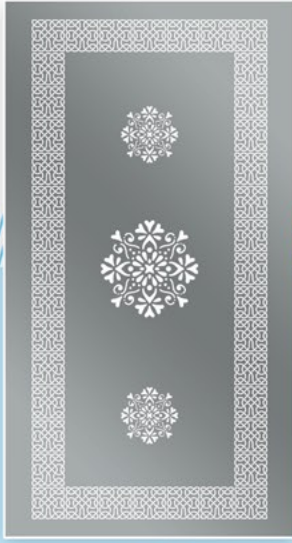

PS100



PS101



PS102



PS103



PS104



PS105



PS106

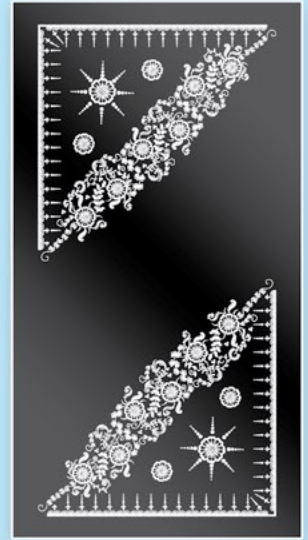

PS107



PS108



PS109

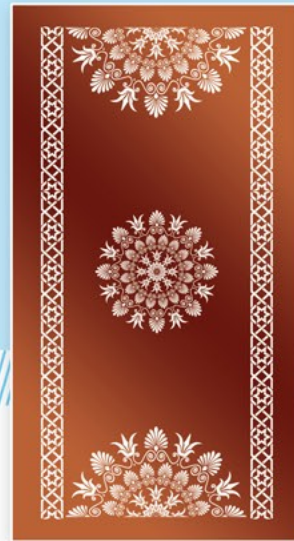

PS110



PS111



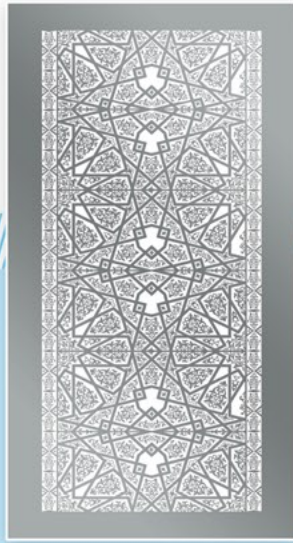

PS112



PS113



PS114

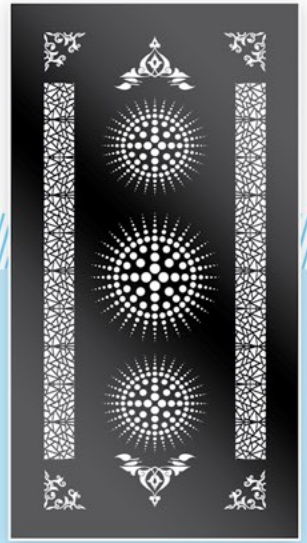

PS115



PS116

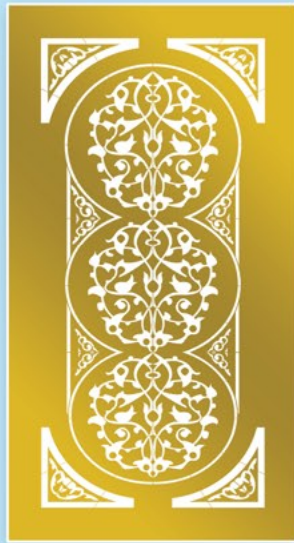

PS117

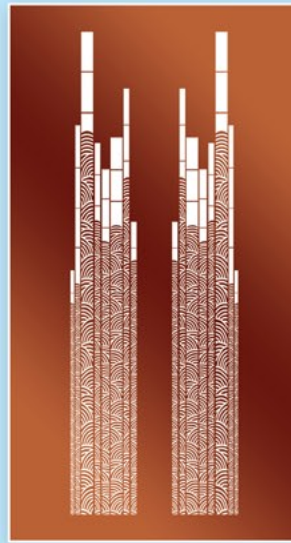

PS118



PS119

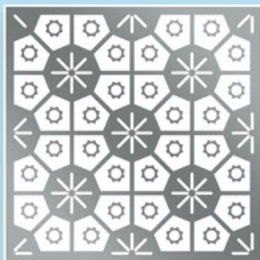

PS200



PS201

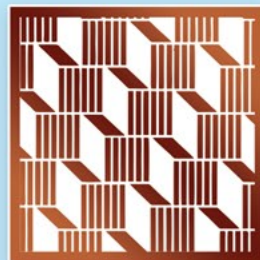

PS202

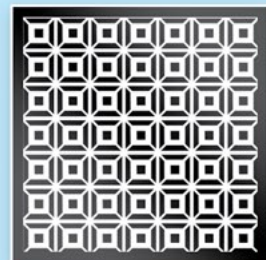

PS203

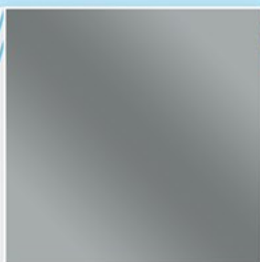

SILVER



GOLD

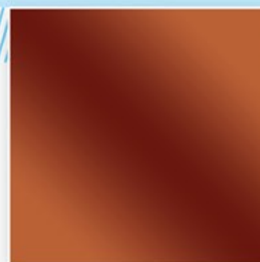

COPPER



BLACK

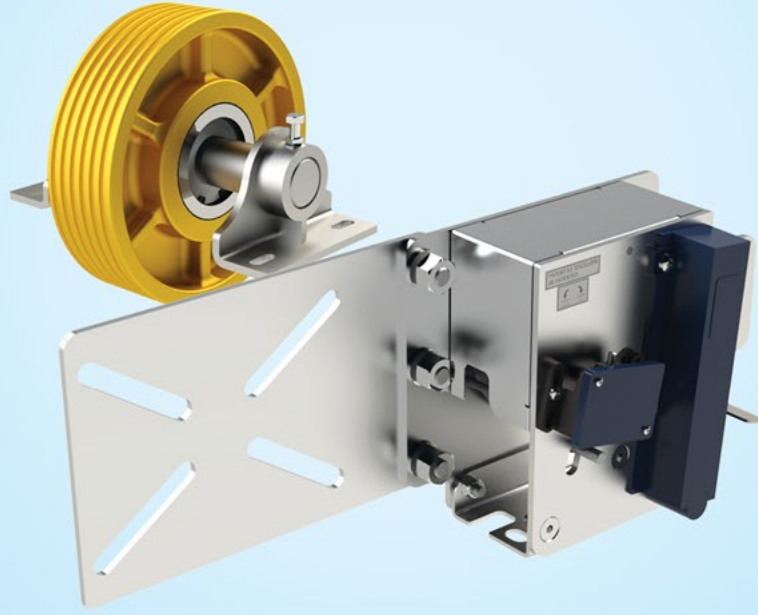

قطع الغيار

spare parts    запчасти  
yedek parçalar



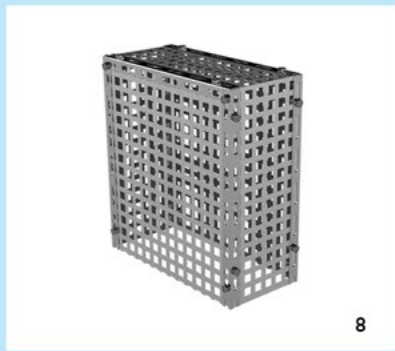
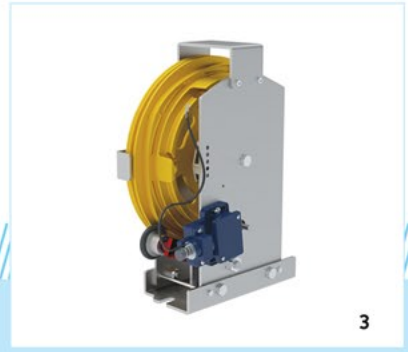
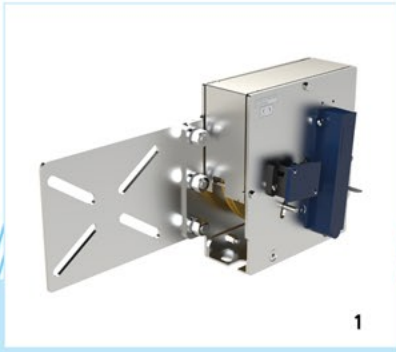

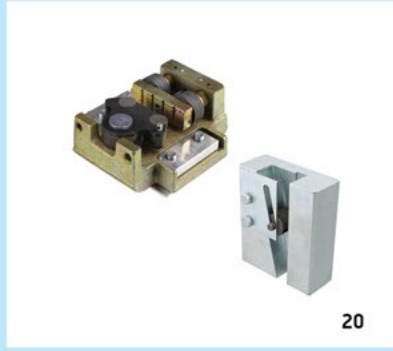



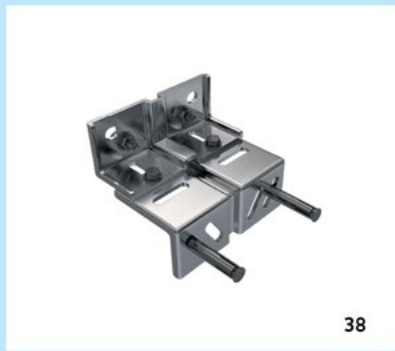
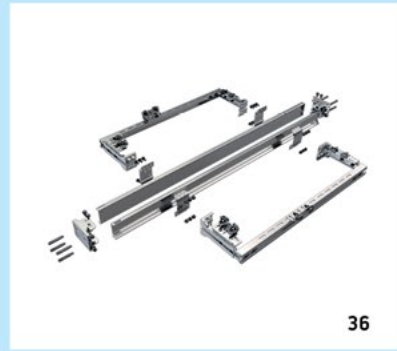

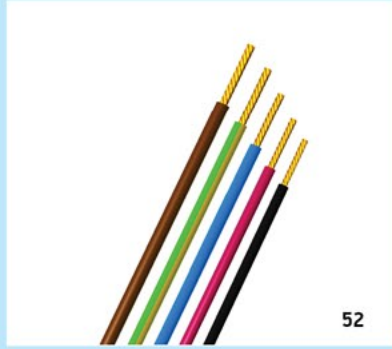
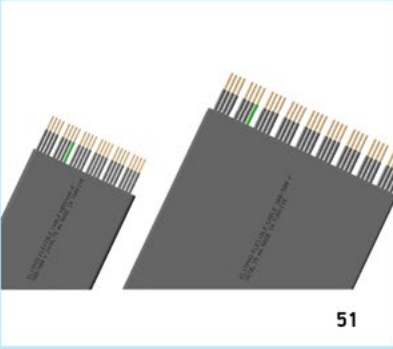
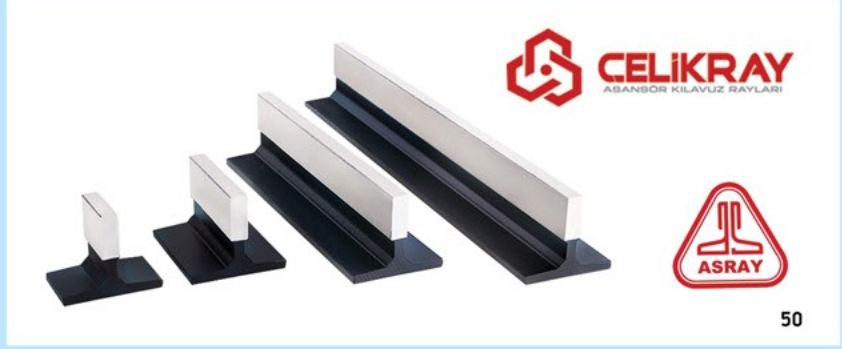
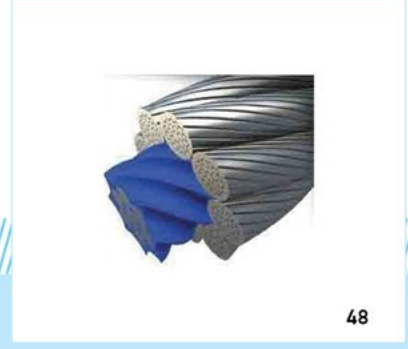
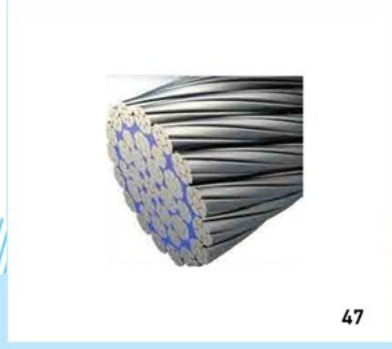



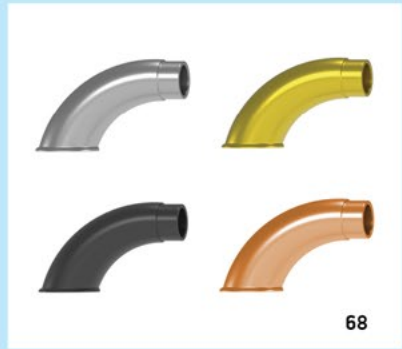
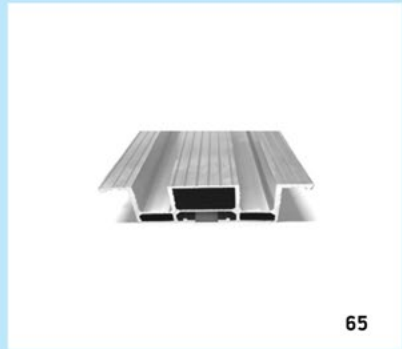

güncel teknolojiler  
ve tecrübemizle...

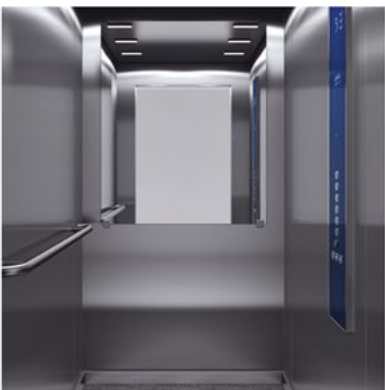
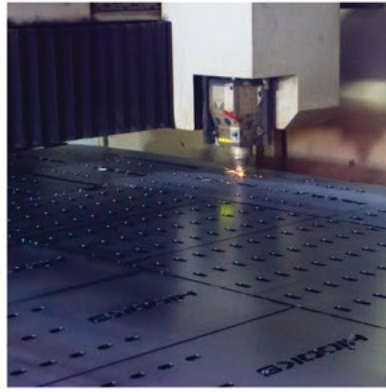

up to date technology  
and experience...





güncel  
ve teknolojiler  
tecrübemizle...



**Hidoks Asansör İnşaat Makine San. Ltd. Şti.**

**FABRİKA** : Fevzi Çakmak Mah.  
Konsan San. Sif. 10728 Sk. No:5  
**KONYA / TÜRKİYE**

**TEL** : +90 (332) 237 66 55  
**FAKS** : +90 (332) 238 91 00

**KULU ŞUBE** : Yeni Mahallesi  
Ayyıldız Sif. Kızılay Apt. No: 1/2  
**KULU / KONYA**

**TEL** : +90 (332) 641 42 00  
**GSM** : +90 (544) 650 25 16

up to date technology  
and experience...



[www.hidoks.com.tr](http://www.hidoks.com.tr)  
[bilgi@hidoks.com.tr](mailto:bilgi@hidoks.com.tr)